

GREAVES  
ELECTRIC  
MOBILITY

  
AMPERE



# NEXUS

FOR THE ONES WHO TAKE CHARGE

[www.ampere.greaveselectricmobility.com](http://www.ampere.greaveselectricmobility.com) | 080 45560700

## FOREWORD

Dear User,

Congratulations on purchasing the Ampere NEXUS Electric Scooter and joining our growing numbers of quality-conscious EV customers with a love for the environment. We take great pride in the quality and workmanship that goes into every Ampere vehicle. We hope you will, too.

This Owner's Manual explains how to operate your new Ampere NEXUS. Please read the instructions carefully and familiarize yourself with the operating mechanism, control, and maintenance requirements. This will help you get the best out of your Ampere EV and assure a safe, trouble-free ride.

All the information and specifications provided in this Manual are correct at the time of printing. However, as a result of Ampere's continual product improvement process, Ampere reserves the right to make changes at any time, without any prior notice.



## INTRODUCTION

Electric Vehicles (EVs) are gaining a strong following across the country. With lower maintenance and running costs as compared to a conventional petrol vehicle; EVs also offer the added benefits of reduced carbon footprint and zero emission.

Established in 2008, Ampere has the firm backing of a lineage of 164+ years of Greaves. With an extensive authorized dealer network across 350+ locations, you have the Ampere assurance wherever you go.

Ampere's range of trendy and cost-effective EVs has taken the world of e-mobility by storm. With 15 years of EV experience under our belt, we make Everyday Mobility exciting.



**YEARS**

OF ELECTRIC VEHICLES EXPERIENCE



**3,00,000+\***

HAPPY CUSTOMERS & GROWING

**2.7+\***

BLLION ELECTRIC KILOMETRES



**40,00,000+\***

EQUIVALENT TO PLANTING TREES

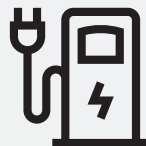

**6,00,00,000+\***

LITRES OF PETROL SAVED

\*As on April 2024

# AMPERE ASSURANCE



**NEAR YOU, WITH YOU,  
ALWAYS**  
PAN INDIA SERVICE TOUCHPOINTS



**PROFESSIONAL  
EXPERTISE**  
COMPANY - TRAINED TECHNICIANS  
AT ALL DEALERSHIPS

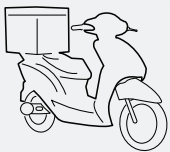

**ROADSIDE ASSISTANCE**



**TOLL - FREE SUPPORT**  
FOR IMMEDIATE QUERIES  
1800 - 123 - 9262



**3 YEARS  
WARRANTY + EXTENDED  
WARRANTY OPTIONS**



**PROMPT &  
RELIABLE SERVICE**

# CONTENTS

INTRODUCING YOUR NEXUS.....	6
SAFETY & FEATURE.....	10
SPECIFICATIONS.....	12
VEHICLE CONTROLS.....	13
OPERATING INSTRUCTIONS.....	19
HOW TO CHARGE YOUR NEXUS.....	20
SETTINGS .....	26
TAKING CARE OF YOUR NEXUS.....	43
VEHICLE MAINTENANCE SCHEDULE.....	47
SERVICE & SUPPORT - NEXUS .....	50

## 1. INTRODUCING YOUR NEXUS

Our electric vehicles are a product of immense research and innovation, carefully designed to power India through New Age Energy.

In this ambitious journey, we want to change the way India moves, starting with the gullies.

Why gullies? Because they are the threads that inspire the culture and weave the stories of India.

Take charge of your journey with us and our sustainable mobility. Let's make Every Gully Electric, and ride towards a greener planet.



**AMPERE**

## Overview

### Front Side View

1. Indicator Lamp LH
2. CBS Lever
3. Head Lamp with DRL
4. Front Brake Lever
5. Indicator Lamp RH

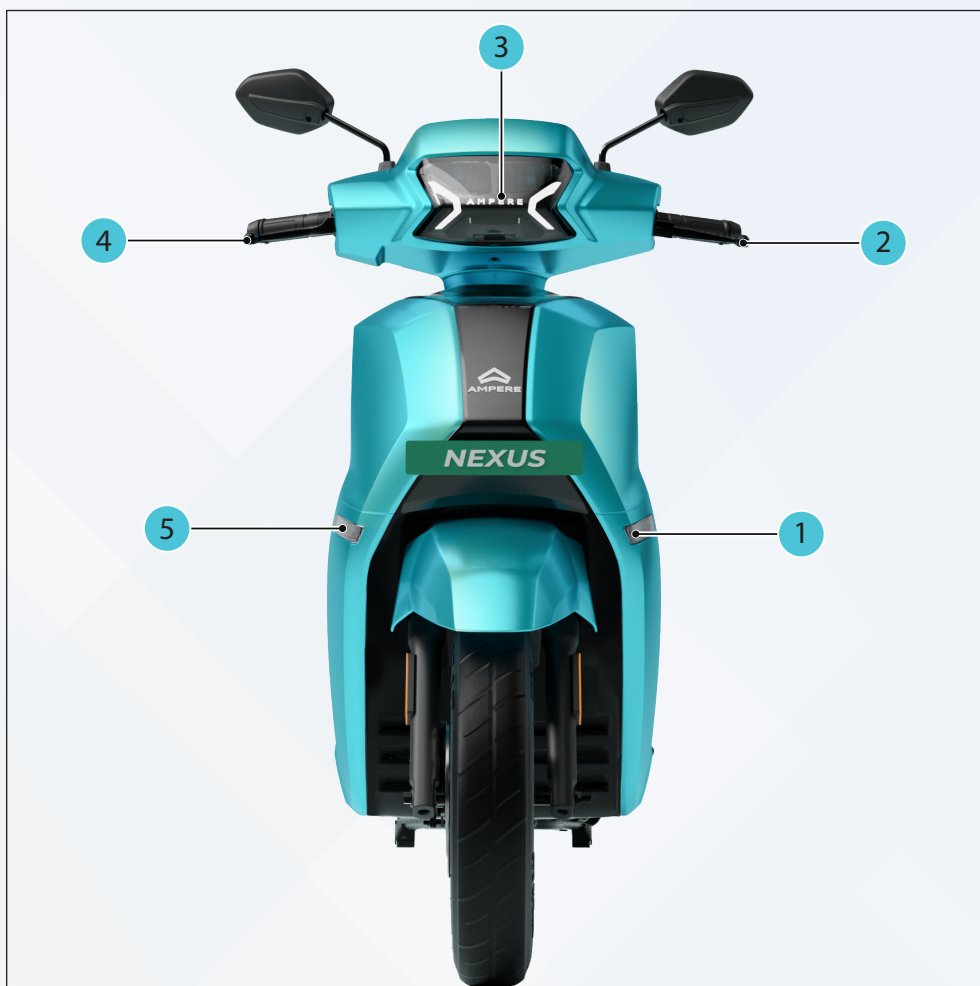

Fig. 1

### Rear Side View

1. License Plate Lamp
2. RH Panel Switch
3. TFT Instrument Cluster
4. LH Panel Switch
5. Tail cum Brake Lamp



Fig. 2

### Left Side View

1. Side Stand
2. Pillion Foot Rest LH
3. Swing Arm Cover LH
4. Ladies Foot Rest
5. Seat Assembly
6. Vehicle Charging Port



Fig. 3

### Right Side View

1. Pillion Foot Rest RH
2. Center Stand
3. Disc Brake
4. Electronic Throttle
5. Rear View Mirror
6. Handle Lock
7. Pillion Grab Handle
8. Swing Arm Cover RH



Fig. 4



## Vehicle Identification

- The frame and motor serial numbers serve as the primary identifiers for your vehicle within its model type. These serial numbers are essential for dealership support in ordering parts and accessing specialized information.
- The Vehicle frame serial number is punched on rear side of the frame below the seat assembly.



Fig. 5

- The motor serial number is stamped on the motor housing.



Fig. 6

## 2. SAFETY & FEATURE

Following Safety Precautions are recommended to avoid any accident & for safe operation, while using the electric vehicle.

### Safety

Operating this vehicle safely is an important responsibility of the rider. To help you make safe decisions while driving the scooter, we have provided necessary operating procedures and other information in this manual. This information alerts you on potential hazards that could cause injury to you or others. Since it is not possible to warn you about all the hazards associated with operating or maintaining the scooter, you must use your own judgment. You will find important safety information in following form in this manual. These words carry the following instructions:

#### **Note:**

This message provides further clarification for clear understanding of any particular.

#### **Caution**

This message indicates special procedures or precautions to be followed to avoid damage to the vehicle.

#### **Warning**

Disregarding this message might result in accidents or injury to the rider.

#### a) For Safe Driving

- We are providing below some simple advice, which will be helpful to you for safe driving in daily usage. Your driving skills and your "Knowledge of Road Traffic Rules" form the foundation for safe driving practices.
- We suggest that you practice driving your vehicle in a non-traffic situation until you are thoroughly familiar with your scooter and its control.
- Do not drive the scooter when the motor is submerged in water condition.

#### b) Safety Equipment Carrying

- As a precaution, appropriate protective helmets must be worn in accordance with the recommended standards.

#### c) Drive Within The Boundaries Of Your Own Skills Always

- On bad surface roads reduce the speed and drive cautiously. Don't jam the brakes on wet surfaces, on rough roads or on slippery roadbeds. While going down on slopes, reduce the speed by closing the throttle control. Make the deceleration easier by using the brakes, but don't apply brakes too long, to avoid dangerous overheating which in turn reduces efficiency before taking a curve close the throttle. While traveling on gradients, change into power mode to get the required pick-up.

#### **Note:**

**Adjustments and repairs, if necessary, should be done by an AMPERE / GEMPL authorized service center only.**

#### d) Riding With License

- Never permit a guest to ride your electric scooter without proper instructions and license as per applicable state laws.

#### e) Drinking and Driving Don't Go Together.

- Driving, anytime, anywhere, under the influence of alcohol or drugs, is dangerous to you, your family, the passengers, and to everyone else on the road, alcohol or drugs reduce your awareness and lead to accident.

#### f) Floorboard Weight Balance

- Do not overload the floorboard and it's always better to distribute the weight on the floorboard for better ride handling.



#### g) Avoid Immediate Charging After Rain

- If you have been riding in the rain, wait for about 15 minutes before plugging in the electric scooter to the NEXUS charger or wipe off the water on the port using a soft dry cloth.

#### h) No Alteration

- Any alteration or modifications to the electric scooter is strictly non-advisable. This may cause unsafe electric scooter operations.

### Safety & Security Features

- Side stand indication 
- Reverse mode 
- IP67 Rated Li-Ion battery with LFP chemistry
- IP67 Rated PMSM motor

### Add - On Features

- Protection cover for belt
- Protection cover for controller
- Disc brake with CBS braking
- Vehicle enabled with 4 driving modes, ECO/CITY/POWER/REVERSE
- Twin rear suspensions for safe shock absorption and comfort

### Additional Features

- Air vent for cooling the electrical parts
- Mid mount motor with belt drive

### 3. SPECIFICATIONS

#### Main Technical Parameter

	Parameters	Value	Units
Vehicle Speed	ECO	42	kmph
	CITY	63	kmph
	POWER	93	kmph
	Limp home speed	42	kmph
	Reverse	3	kmph
Battery Pack	Battery pack voltage	51.2	V
	Battery capacity	3	kW-h

#### Specifications

S.No	Description	Inputs
1	Kerb Weight	128 kg
2	Motor characteristics	Continues Power - 3.3 kW
		Peak Power - 4.0 kW
		Motor Max. Torque - 35 Nm
3	Max Speed	80 Kmph
4	Max Loading Capacity	150 kg
5	Charging Time	3.5 - 4 Hrs
6	Range @ GVW	ECO - 90 to 110 km
		CITY - 75 to 90 km
		POWER - 55 to 65 km
7	Continuous Gradient (GVW)	16°
8	Battery	3 kW-h 51.2 V LFP
9	Charger Specification	15 A / 58.4 V
10	Motor Specification	PMSM
11	Brake Type	Front - Disc: 200 mm dia disc
		Rear - expanding shoe type 130 mm dia drum
12	Fork Type - FR	Telescopic front fork
13	Fork Type - RR	Adjustable hydraulic twin tube shock suspen- sion
14	Tyre - Font & Rear	90 / 90 - 12 54J (Tubeless)
15	Ground Clearance	Unladen - 170 mm
		Laden - 130 mm
16	Wheel and Wheel Base	12 Inches Alloy, 1319 mm
17	Modes	ECO / CITY / POWER / REVERSE

#### Disclaimer:

- The range of the product will vary based on usage conditions such as variable load and speed.

#### Note:

- GVW = Kerb. Weight +Max. Loading Capacity

## 4. VEHICLE CONTROLS

### Handlebar Controls



Fig. 7

- |                           |                               |
|---------------------------|-------------------------------|
| 1. TFT Instrument Cluster | 6. Glove Box Hook             |
| 2. Left Hand Switch Panel | 7. Lock Handle / Seat / Power |
| 3. CBS Lever              | 8. Right Hand Switch Panel    |
| 4. USB Charging Port      | 9. Electronic Throttle        |
| 5. Vehicle Charging Port  | 10. Front Brake               |

### LH and RH Control Identification

#### LH Hand Switch Panel:

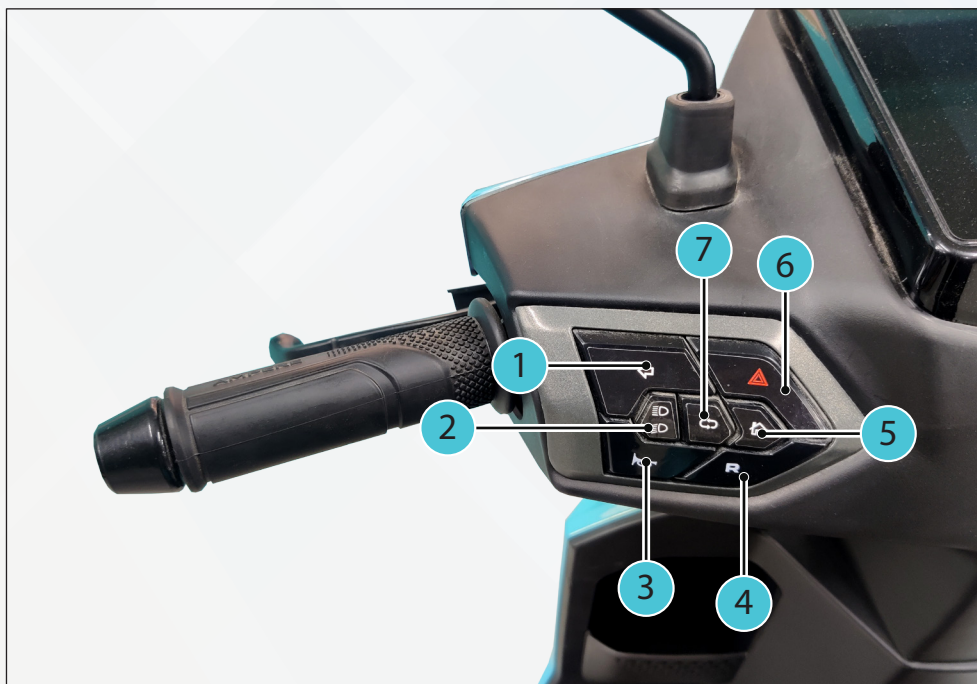

Fig. 8

- |                     |            |           |
|---------------------|------------|-----------|
| 1. Turn Left Switch | 4. Reverse | 6. Hazard |
| 2. High / Low beam  | 5. Home    | 7. Menu   |
| 3. Horn             |            |           |

### 1. Turn Left Switch

Press left indicator button in left hand switch panel to switch ON turn left indicator. To switch OFF again press same button. Auto cutoff in 1min if no button pressed.

### 2. High / Low Beam Switch

Press the high beam indicator button in left hand switch panel to switch ON the high beam light. To switch OFF again press the same button.

### 3. Horn Switch

Press the horn switch to create the horn sound to alert approaching vehicles.

### 4. Reverse Switch **R**

Press & Hold the reverse switch to move the vehicle Reverse Direction. Reverse speed is maximum 3 kmph.

(TFT display will indicate the reverse mode activation lamp).

### 5. Home Switch

Press home button from left hand side switch panel, default screen appears.

This screen provides below info.

- Speed, SOC, RPM, Odo
- All Tell Tale & Warning indicator

### 6. Hazard Switch

Press the hazard button in left hand switch panel to switch ON hazard indicator. To switch OFF again press same button. Auto OFF after 5min if no button pressed.

### 7. Menu Switch

- Press the Menu switch to access the functions and instructions.
- Long press 5 seconds for Trip reset.

### RH Hand Switch Panel:

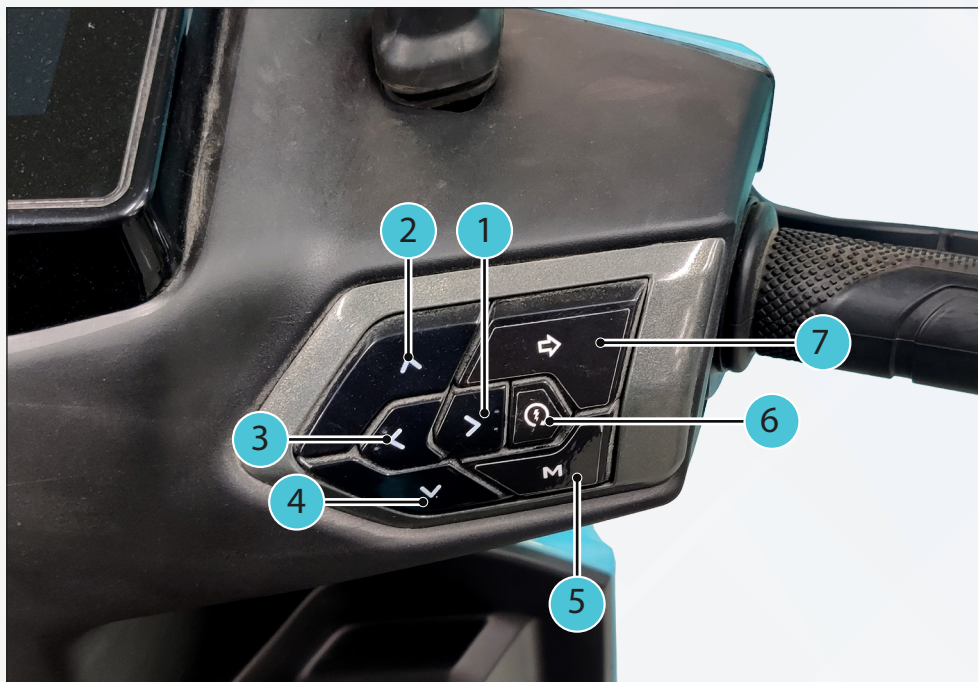

Fig. 9

- |                         |                           |                           |
|-------------------------|---------------------------|---------------------------|
| 1. RH Transition Switch | 4. Down Transition Switch | 6. E Start / Ready Switch |
| 2. UP Transition Switch | 5. Mode                   | 7. Turn Right Switch      |
| 3. LH Transition Switch |                           |                           |

## 1. Right (1), UP (2), Left (3) and Down (4) Transition Switch:

LH, RH, UP and Down transition switch change the screen information, data and metrics using graphics or visual representations of numbers. The screen is controlled by an operator who monitors and controls the multi-functional LCD display.

LH Transition Switch ( < )      UP Transition Switch ( ^ )

RH Transition Switch ( > )      Down Transition Switch ( v )

## 5. Mode Switch **M**

Mode switch is located on the RH panel switch, it allows to switch between following modes.

- ◇ ECO mode
- ◇ City mode
- ◇ Power mode

### Mode Switch Operation

- » First press – City
- » Second press – Power
- » Third press – City
- » Fourth press – ECO
- » Fifth Press – City

Continue the mode as per the sequence mentioned.

### ◇ ECO Mode

The Eco mode restricts the speeds to around 40 kmph and it is more than adequate in city traffic. It's the most battery - friendly driving mode, helping to make your driving more efficient.

### ◇ City Mode

The City mode restricts the speeds to 60 kmph. City mode is the most common and popular mode for electric scooters. It gives users a smooth and steady ride, with more control overall.

### ◇ Power Mode

- The Power mode restricts the speeds to around 80 kmph. Power is the most thrilling of the electric scooter riding modes, as it's ideal for experienced riders who enjoy a better acceleration.
- Use power mode during overtaking and Gradient Climbing

### ◇ Limp Home Mode

When Battery percentage goes below 10% Limp home mode will be activated and Limp home mode indication will be display on cluster.

## 6. Ready / E - Starter Switch (⌘)

When the ready button is pressed, a ready symbol appears and vehicle ready to move. Ensure the side stand is retracted before the ready button is pressed.

## 7. Turn Right Switch ⇨

Press the right indicator button in right hand switch panel to switch ON turn right indicator. To switch OFF again press the same button. Auto cutoff in 1min if no button pressed.

## Handle Lock / Seat Lock / Power

### Handlebar Lock and Unlock Operation

- Unlock: Insert the key, push it down and turn clockwise.
- Lock: Insert the key, push it down and turn anti-clockwise.

**i Note:** Handle lock will function only if the handle is tilted towards left side.

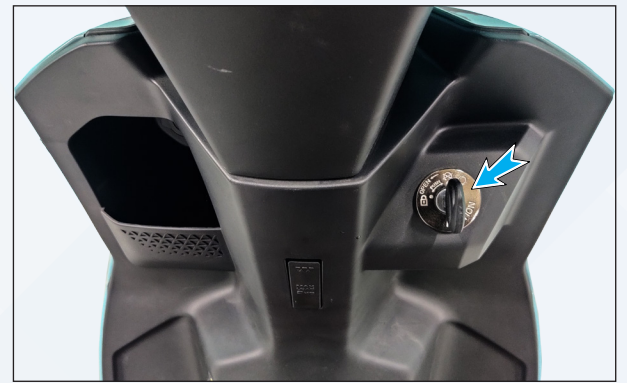

Fig. 10

### Lock Control and Operation

- ON: Turn the Key Clockwise to Power ON.
- OFF: Turn the Key Anti-clockwise to Power OFF.
- SEAT LOCK: Turn Anti-clockwise from OFF position.
- LOCK: Handle lock, Power OFF.

## Digital TFT Display

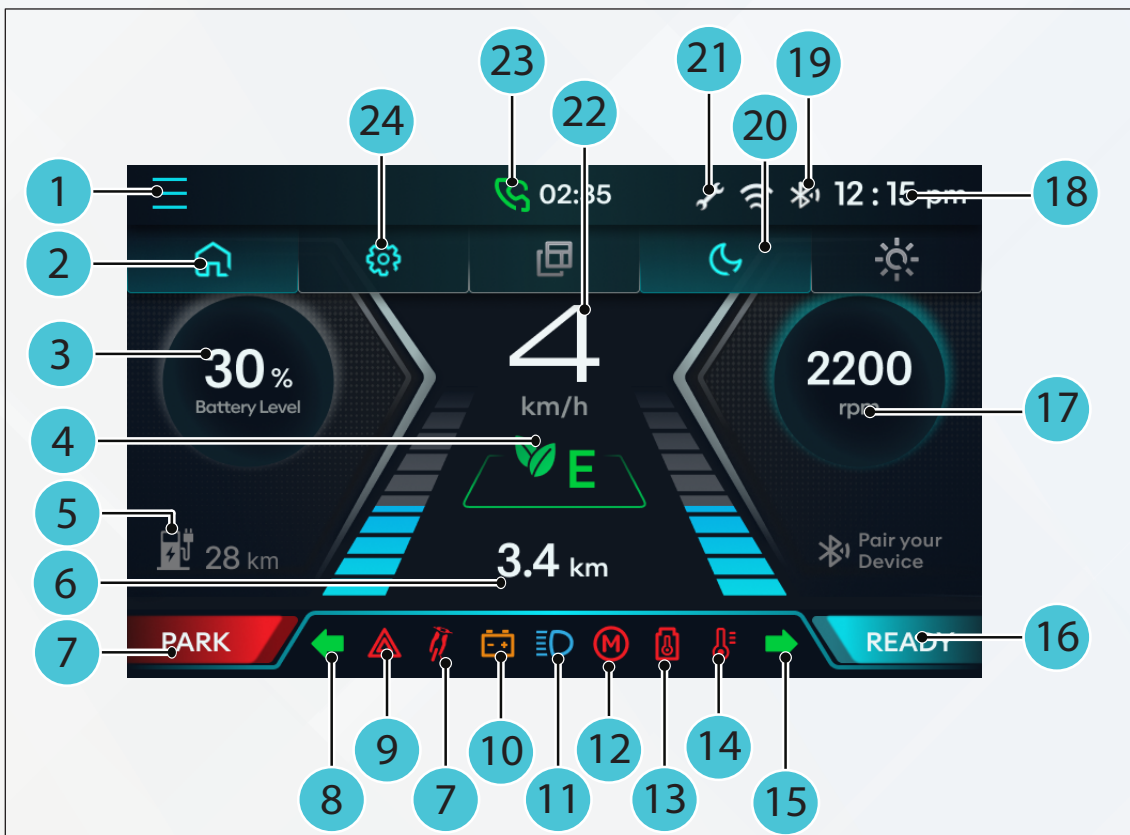

Fig. 11

### 1. Menu

It consists of lists that provides commonly used functions and can be used to navigate through menu option.



### 2. Home

Home is used to return you to the main page or homepage of whatever application or program you are using.





### 3. Battery SOC in Percentage

Battery SOC level indicator – this shows the battery current charge level in percentage.

SOC Percentage	SOC Icon Colour
0 - 10 %	Complete Background Red
10 - 20 %	Red 
21 - 60 %	Grey 
61 - 100 %	Blue 

### 4. Mode (Eco, City, Power)

Switch ride mode from Eco / City / Power as per driving and road conditions.

- ECO: For energy saving low speed performance 
- CITY: For optimum speed performance 
- POWER: For high-speed performance 

### 5. Distance to Empty (DTE) in KM 28 KM

It helps the rider to know how much distance can be traveled with the remaining battery charge. This is an indicative number the actual number may vary with reference to drive road load conditions

### 6. Odometer Display

The odometer display has two functions, one shows the total distance the vehicle has traveled till date and the other is a call alert display instead of the odometer display.

### 7. Park & Side Stand

When side stand is used in vehicle, side stand indicator & park indicator appears. Side stand indicator disappears when the side stand is retracted to its up position.

### 8. Turn Left Indicator

The green colour light blinks when left indicator lights are operated to indicate the direction of turning. To turn off the indicator lights press again same button. Indicator lights will turn off automatically after 1min if no button pressed.

### 9. Hazard Indication

Both left and right indicator lights blinks when hazard light is operated to indicate to alert the incoming vehicles regarding an emergency. Hazard lights will turn off automatically after 6 min if no button pressed.

### 10. Battery Warning

When BMS error is detected, the respective light will be in constant ON.

### 11. High Beam

The blue colour light indicates that the headlamp is in the high beam position.

### 12. Motor / Controller Warning

When MCU / Motor error is detected, the respective light will be in constant ON.

### 13. Thermal runaway early warning

Battery High Temperature alarm

When Battery high temperature warning is detected, the Battery & Temperature symbol blink @ 2sec ON & 2 sec OFF along with Buzzer ON 2sec ON & 2 Sec OFF.

#### Thermal Runaway

When Thermal runaway warning is detected, the Thermal runaway symbol will be Constant ON along with Buzzer.

## **Caution**

When thermal runaway occurs, it is recommended to stop the vehicle to safe place within 5 minutes after the thermal run away occurs. This 5 minutes is a crucial time and it is as per statutory requirements. During thermal runaway the performance of vehicle might come down drastically but only helps to reach a nearest safe place.

## 14. **Motor/ Controller Over temperature**

When Motor & MCU attain over temperature, the respective symbol will be in constant ON.

## 15. **Turn Right Indicator**

The green colour light blinks when right indicator lights are operated to indicate the direction of turning. To turn off the indicator lights press again same button. Indicator lights will turn off automatically after 1min if no button pressed.

## 16. **Ready (to move)**

When the power ON, ready symbol appears on the screen and the vehicle is ready to move. Ensure the side stand is retracted to its up position before the ready button is pressed.

## 17. **Motor RPM**

RPM indicates the motor revolution per minute.

## 18. **Time AM/PM**

The instrument cluster is equipped with a digital clock that displays the current time in a 12-hour format and this feature is exclusively activated when a Bluetooth connection is established.

## 19. **Bluetooth**

Bluetooth indicates vehicle is connected with rider's mobile via mobile app.

## 20. **Dark Mode**

Dark / Light Mode enhances user experience by providing flexibility in adapting the display to different lighting conditions and individual preferences, contributing to safer and more enjoyable rides.

- Dark Mode is often favored for night time rides to minimize eye strain and maintain focus on the road.
- Light Mode ensures clear visibility of information during daylight hours.

## 21. **Service Due Alert**

Service Due Alert is a notification that prompts the rider that the scooter is due for maintenance or a service check.

The alert is triggered by the distance traveled since the last service. It notifies the rider of the accumulated mileage and encourages them to schedule a service within a specified range.

## **Note:**

**This option is for indicative purpose only. Monitor the odometer reading and adhere to the maintenance schedule.**

## 22. **Vehicle Speed Display**

The vehicle speed display indicates the current speed of the vehicle in kilometers per hour (km/h).

## 23. **Caller Time Display**

In case if any call is attended this features notifies users about incoming calls , missed call's & display relevant information on the screen.

## 24. **Profile**

Setting to configure various system and application settings, such as profile setting, application settings and vehicle information settings.

## 5. OPERATING INSTRUCTIONS

### Starting the Vehicle

- Position comfortably on the scooter and retract the side stand.
- Turn the Lock Handle / Power ON and wait till the display is ON.
- Check the battery charge percentage on the instrument cluster.
- Press start switch and hold the brake lever to activate the motor.
- Select the mode as needed to move the vehicle – ECO / City / Power.
- Release the brake and apply the throttle to move the scooter.

#### **i** Note:

**Do not turn the throttle until you are in the position to drive.**

### Stopping the Vehicle

- a. To stop, release the throttle and apply the brake / brakes.
- b. Turn the power key to OFF position.

### Accelerating the Vehicle

- a. Once seated firmly, accelerate the throttle gradually.
- b. In order to increase the speed, adjust the throttle further inwards.
- c. Always accelerate gradually, especially when setting off or climbing up a slope in order to save power.
- d. Switch ride mode from Eco (↔) City (↔) Power as per driving and road conditions (LCD will display the selected Drive Mode).
- e. Always drive in ECO mode for better range.

### Braking the Vehicle

#### Combined Braking System

- a. The combined braking system (CBS) of the scooter activates both front and rear brakes, when the rear brake is applied.
- b. However, to ensure effective braking, always apply both brakes simultaneously.

#### **i** Note:

**While reversing ensure that the Brake levers are completely disengaged (no parking indication on TFT Display) and the side stand is up (no side stand indication on TFT Display).**

## 6. HOW TO CHARGE YOUR NEXUS

### Charger

- Chargers should not be kept in ground when charging or exposed to rain, it should be kept in covered area when charging.



Fig. 12

- Charge cable AC end.



Fig. 13

### Connecting For Charging

- Push the lid inside and rotate to open the charging cover.



Fig. 14

- Charger port and charging port end.

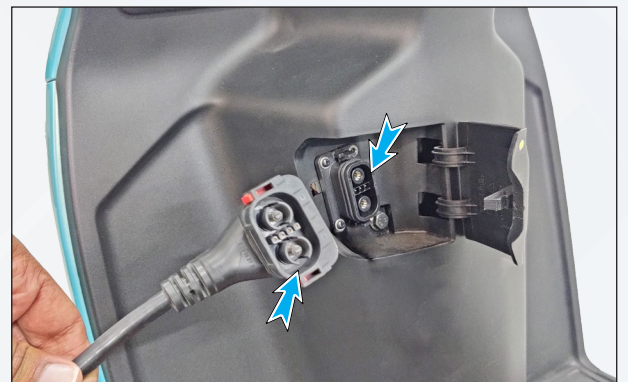

Fig. 15

- Press the charger in charging port and ensure that it's properly plugged with the charging port.

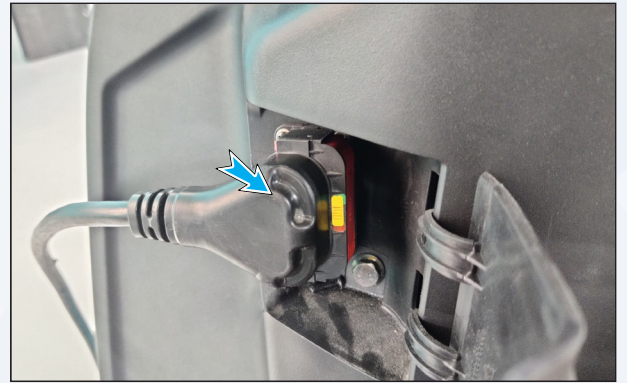

Fig. 16

- Slide yellow lock in the arrow direction (green colour) to lock the charger.

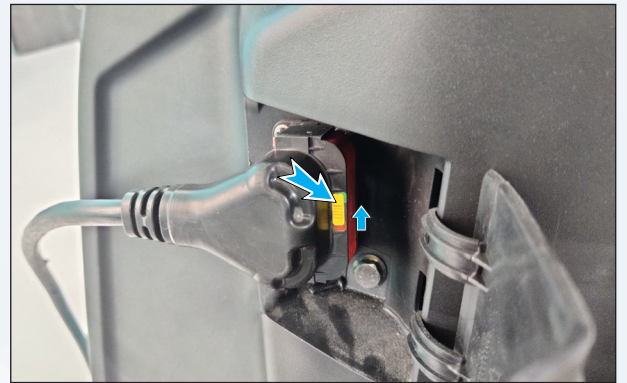

Fig. 17

- Please ensure the AC socket wiring with proper earthing (Ground), advisable to fix MCB / RCCB.
- Plug in charger cable AC end to AC socket and turn ON the switch.



Fig. 18

## Disconnecting From Charging

- Turn off the switch and take out charger cable AC end from AC socket.
- Slide the yellow lock in the arrow direction (red colour) to unlock the charger from charging port.
- Press the red colour lock button on charger end to remove the charger from the charger port.
- Close the charging cover.



Fig. 19

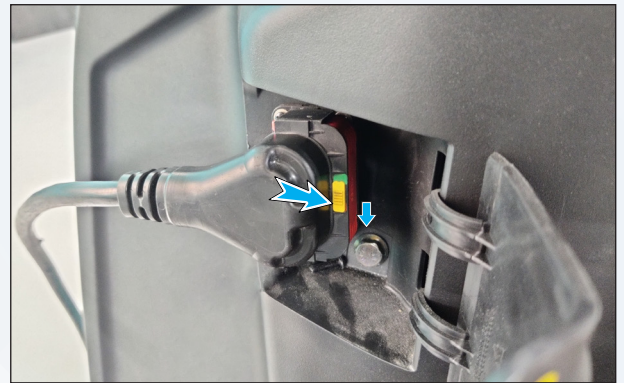

Fig. 20

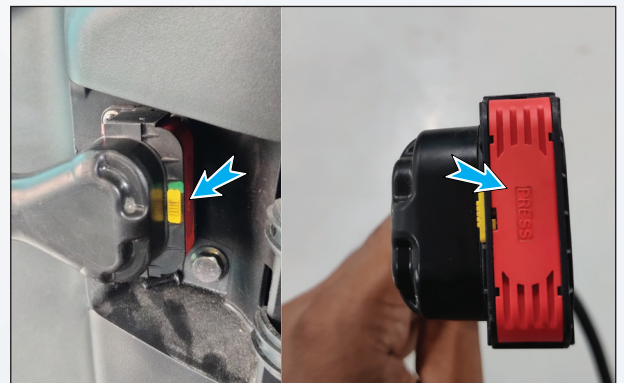

Fig. 21

## Main Technical Parameter and Specifications of Charger

### Characteristics

Items	Specifications
Rated Input Voltage	230 V
Input Voltage Range	180-280 V AC
Input Frequency Range	50 - 60 Hz

### Protection List for Charger:

- Output Short Circuit Protection
- Output Over Current Protection
- Battery Reverse Polarity Protection
- Over Temperature Protection
- High Voltage Breakdown Withstand
- Battery Full Charge Cut-off
- Earth Leakage

### **i** Note:

**This charger is suitable for Indian Power conditions and only for indoor use.**



Fig. 22

## Charger Operations

Item	Instructions	Charger with Lights
Safe Charge Operations	First connect the charger to vehicle charging port and then connect to AC mains.	
To be Charging	When the charger is connected to AC plug and the output end is not connected to the pack, there will be no indication in the LED.	
Be Charging	<p>The charger is connected to the AC plug, and the output end is connected to the vehicle.</p> <p>The LED ON (Green light) indicates the Charging condition.</p> <p>At full charge condition LED flashes with the Green Light.</p>	

Fig. 23

## Charger Usage and Maintenance

### Caution

- Firstly, connect the output cable of the charger into the vehicle charging port and then connect the input cable of the charger to the AC Main Power supply.
- When charging the charger indicator light glows "Green". After the vehicle is fully charged the charging indicator "Flashes with the Green light".
- When the battery is fully charged, first unplug the input cable of the charger from AC mains and then output cable from the vehicle.
- Check & ensure that the voltage supply to the charger is AC 230V. If the supply voltage is irregular or expected to vary drastically, please use a voltage stabilizer or spike buster.
- Please use genuine specific charger. Use Only 15A AC Power Socket for Charging the vehicle as provided only by Ampere.
- Don't charge the vehicle with Charger box in Overhang condition. It will damage the AC cable.
- Always plug the charger directly into the 15A AC Power Socket with proper Earthing / Ground. Do not use extension box while charging.
- Do not let the charger get wet to prevent damage, short-circuit and fire.
- Never plug or unplug the charger using wet hands and do not touch the charger under bad weather conditions involving thunder and lightning.
- Do not keep the charger in dust and damp surroundings.
- Avoid using the charger under direct sunlight.

### When to charge my vehicle?

The vehicle should be charged in the following cases to 100%,

- When the SOC (Charge) of the Vehicle is below 20%.
- Weekly (7 Days) once irrespective of the SOC (Charge) available.

### Where to charge my vehicle?

- Use the charger given along with the vehicle to charge the vehicle.
- Use only 15 A Power Socket (Ensure that it is properly Earth).



## Charger Indications

- Check the LED indications in the charger –

Indications	GREEN LED	RED LED	BUZZER
Fault (Short Circuit / Reverse Circuit)	OFF	ON	OFF
Charging	ON	OFF	OFF
Full Charge	FLASH	OFF	OFF
Earth Leakage	OFF	ON	FLASH

## When to Unplug my vehicle from charging?

- Check the charger LED, if the green LED flashes, you can remove the charger.
- Check the cluster for the charge percentage to show 100%.

DO'S	DONT'S
Charge the vehicle in safe and secured area.	Do not leave the vehicle in charging condition when you plan for outing.
Do a regular check of wall socket and charger plug for damage.	Do not connect charger plug in old or worn-out socket.
Switch OFF and unplug the charger plug if excessive heat observed.	Do not charge the vehicle nearby combustible material like gas, fuel, etc.
Regularly check the charging cable for cuts/damages.	Do not modify the plug of the charger.
Ensure the vehicle is switched OFF before charging.	Charging plug must not be inserted when vehicle is in Power ON condition.
Ensure the main socket switch is in OFF condition before plugin charger AC plug on wall socket.	DO not use the wall socket without switch.
Ensure 15 amps wall socket used to connect the charger.	Do not stretch to too long and connect the charger cable to vehicle.
Use branded wall socket and ensure no loose contacts when charger plug inserted.	Do not connect AC voltage directly to vehicle for charging. That will cause for Fire.
Park the vehicle nearby charger before start of charging.	Do not charge the vehicle in Flood condition.
Charge the battery away from children. Do ensure that they do not play with the appliance.	Do not park the vehicle nearby over temperature or fire area and charge.

## 7. SETTINGS

### Digital Display settings

#### Boot Screen Appears

- When ignition is turned ON, cluster is turned ON & boot screen appears.

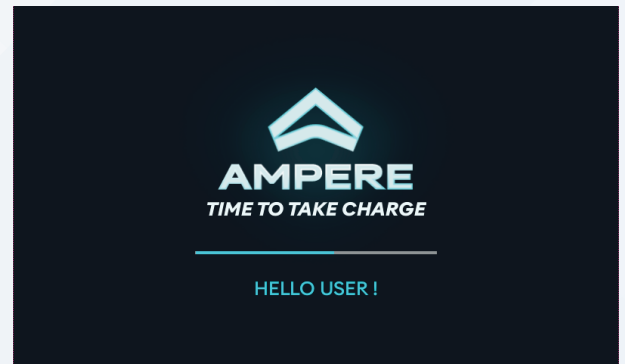

Fig. 24

- After boot screen, instruction screen appears.
- If there is no touch response from the rider on instruction menu screen, automatically moves to default screen after 3 sec.

#### **i** Note:

Appears only in new cluster / after software update for some times (Not permanent)

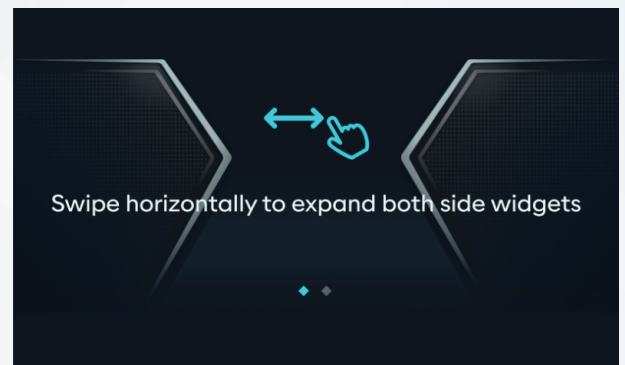

Fig. 25

- Upon right swipe, Bluetooth connected instruction screen appears.

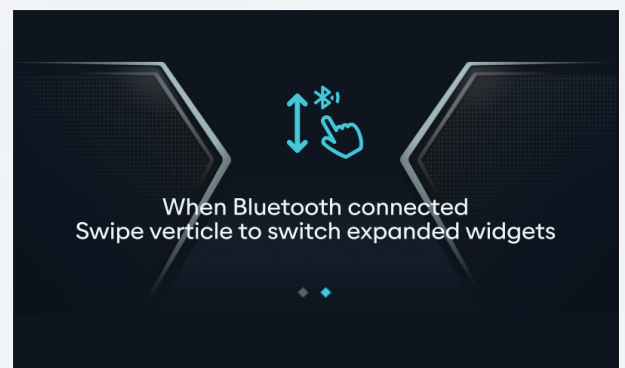

Fig. 26

#### Charging Screen

- When charger plugged in the AC supply & vehicle ignition is turned ON then Charging Screen appears.
- This screen provides the below information.
  - ◇ Charging percentage
  - ◇ Time to full charge

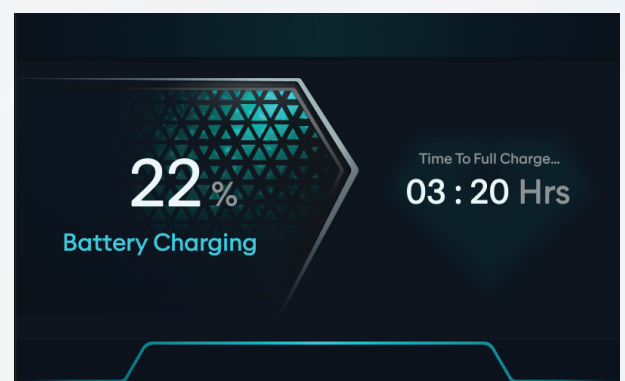

Fig. 27

## Fully Charged Screen

- When charger is plugged in with ignition ON & Charging is completed, Fully Charged Screen appears
- This screen provides the below information.
  - ◇ Charging percentage
  - ◇ Time elapsed

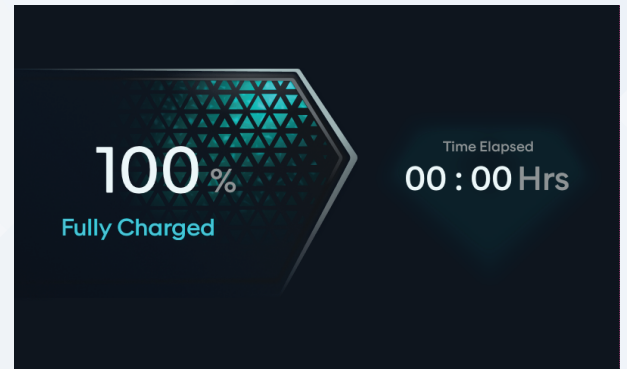

Fig. 28

## Mode Screens

Eco, City, Power modes screens provides the below information. Speed, Odo, SOC with background color - Red (0-20) Blue (21-60) Green (61-100), Rpm with background color - (Green, Grey Red), All tell-tale & indicators, Menu, Wi-fi, BLE, Clock (Bluetooth connected), Service alert, DTE, Ready & Park.

### ECO:

- By default screen will be in ECO mode.

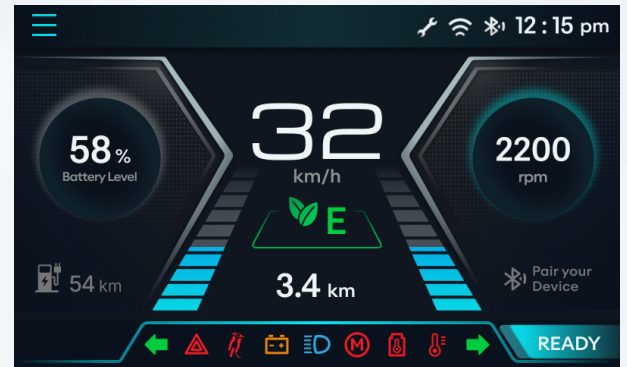

Fig. 29

### City:

- Press Mode button for first time from right hand side switch panel, CITY mode screen appears.

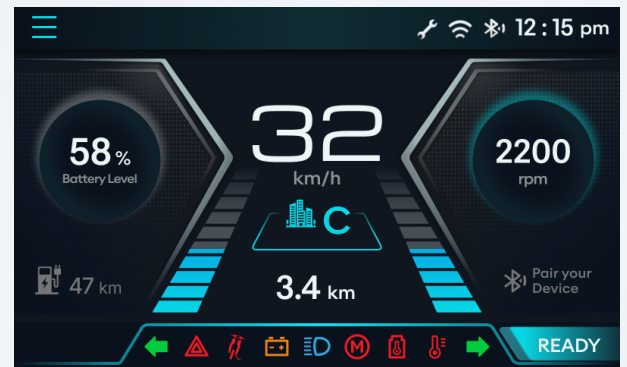

Fig. 30

### Power:

- Press Mode button for second time from right hand side switch panel, Power mode screen appears.

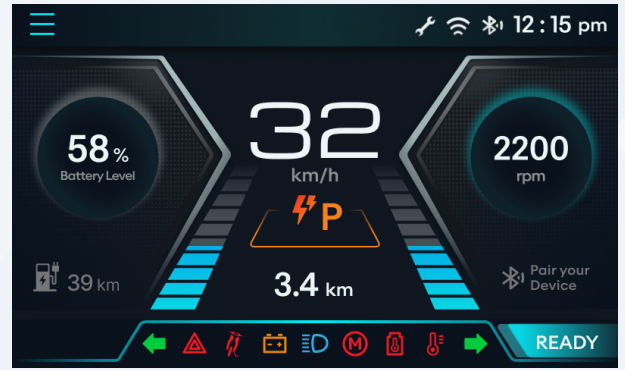

Fig. 31

### Reverse

- Continuously press R button from left hand side switch panel, reverse mode screen appears
- This screen provides the below information.
  - ◇ Speed, Odo
  - ◇ All tell-tale & Warning indicators

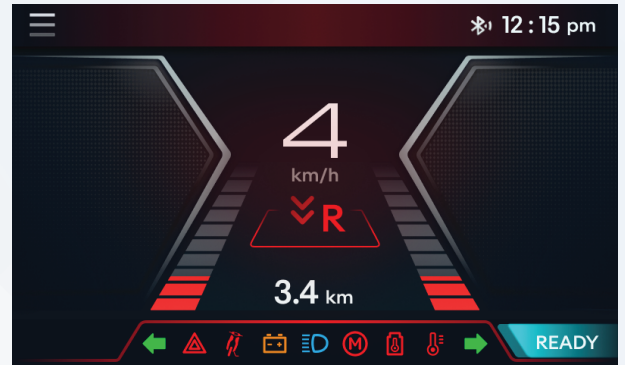

Fig. 32

### Limp Home

- When battery percentage goes below 10%, limp home mode screen appears
- This screen provides the below information.
  - ◇ Speed, Odo, SOC, DTE
  - ◇ All Tell-tale & Warning indicators

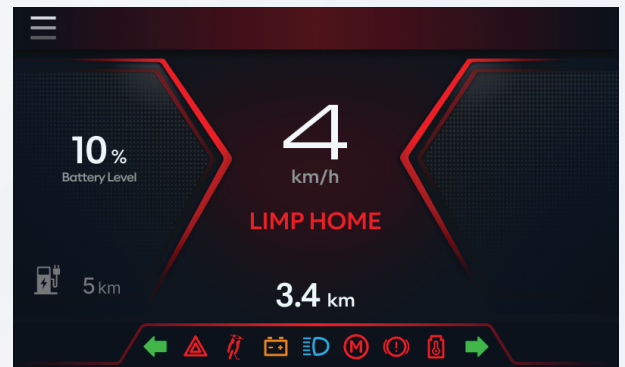

Fig. 33

### Default Screen

- Press home button from Left hand side switch panel, Default screen appears
- This screen provides the below information.
  - ◇ Speed, SOC, RPM, Odo, DTE & Mode
  - ◇ All Tell-tale & Warning indicators

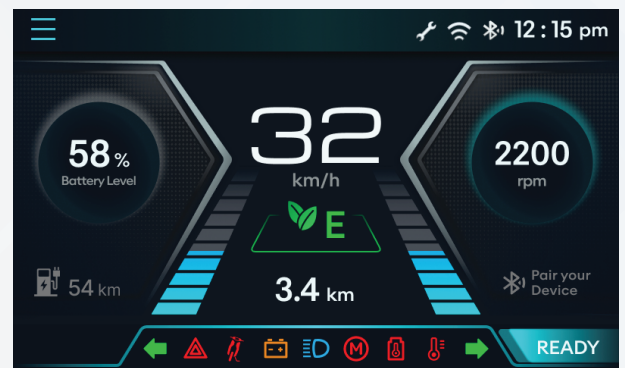

Fig. 34

## Left Transition Charge Stage

- When ignition is turned ON, touch enables & swipe towards right. During vehicle is running, press right arrow button, charge stats screen appears.
- This screen provides the below information.
  - ◇ Last Charge %, Last charging duration
  - ◇ All tell-tale, Speed, Odo, Call & Mode.

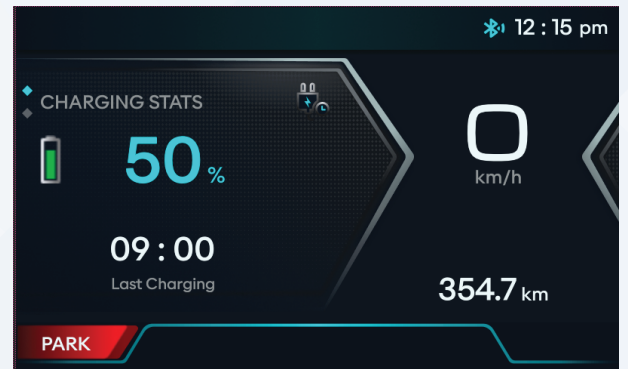

Fig. 35

## Left Transition Music Screen

- When ignition is turned ON, Touch enables & Swipe towards right & up/down or During Vehicle is running, Press Right arrow & up/down button, Music Screen appears.
- This screen provides the below information.
  - ◇ All tell-tale, Speed, Odo, Call & Mode.

### **i** Note:

- Music will be controlled via Bluetooth.
- Only downloaded song can be played in mobile app.

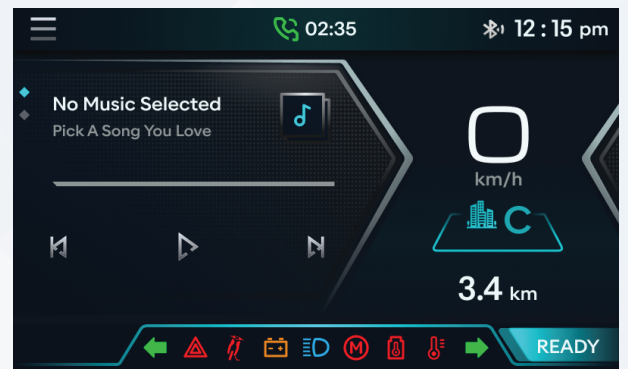

Fig. 36

## Right Transition Trip Stage

- When ignition is turned ON, Touch enables & Swipe towards left. During Vehicle running, Press left arrow button, Trip stats Screen appears.
- This screen provides the below information.
  - ◇ Trip, Avg. Speed, Max. Speed,
  - ◇ All tell-tale, Speed, Odo, Call & Mode.

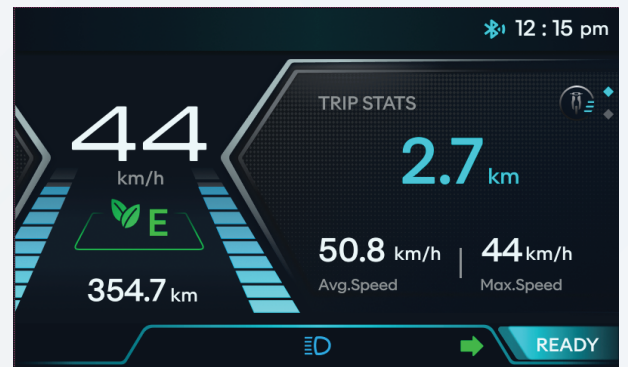

Fig. 37

- If user press Reset switch and holds for 5 sec, the trip stats values will be set to zero.
  - ◇ This Screen sets below info to zero
  - ◇ Trip
  - ◇ Avg. Speed
  - ◇ Max. Speed

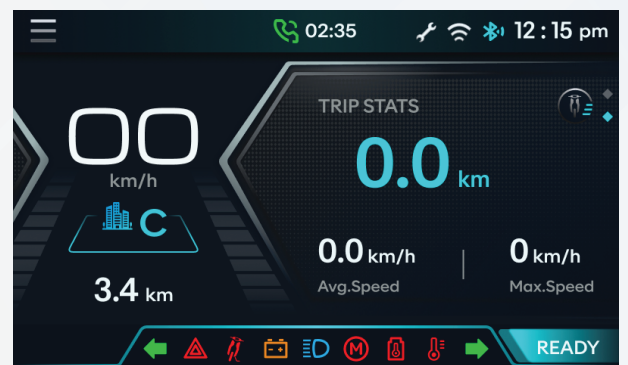

Fig. 38

## Right Transition No Navigation

- When ignition is turned ON, Touch enables & Swipe towards left & down. During Vehicle is running, Press left arrow & up/down button, No navigation Screen appears.
- This screen provides the below information.
  - ◇ All tell-tale, No destination detail, Speed, Odo & Mode.

### **i** Note:

If Bluetooth is not connected / designation not set in mobile app.

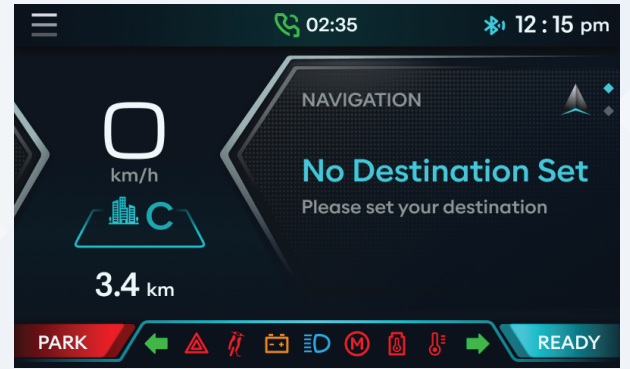

Fig. 39

## Right Transition TBT Screen

- When ignition is turned ON, touch enables & swipe towards left & down or during vehicle is running, press left arrow & down button, turn by turn navigation screen appears.
- This screen provides the below information.
  - ◇ All tell-tale, TBT detail from mobile app, Speed, Odo & Mode.

### **i** Note:

If Bluetooth connected & destination set in mobile app.

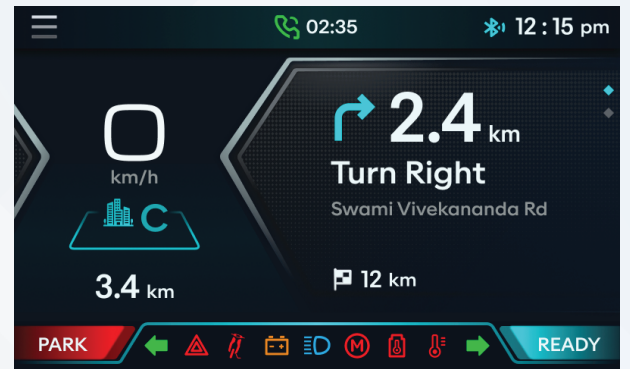

Fig. 40

## Menu Screen

- Press menu switch from left hand side switch panel (shown above), menu screen appears.
- This screen provides the below information.
  - ◇ Home, Profile,
  - ◇ Mode selection (Dark / Light).

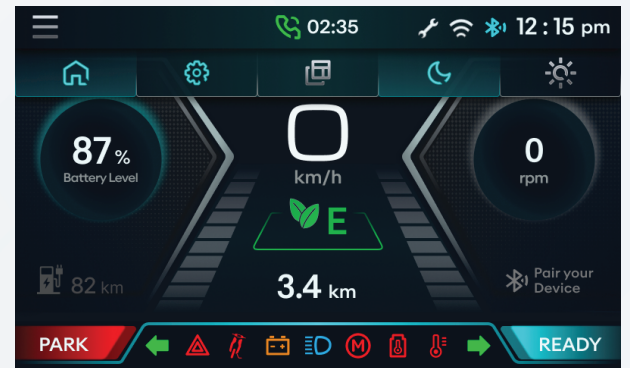

Fig. 41

## Notification screen

- This Screen provides below info.
  - ◇ Name of the caller
  - ◇ Number of missed calls
  - ◇ Duration of the call

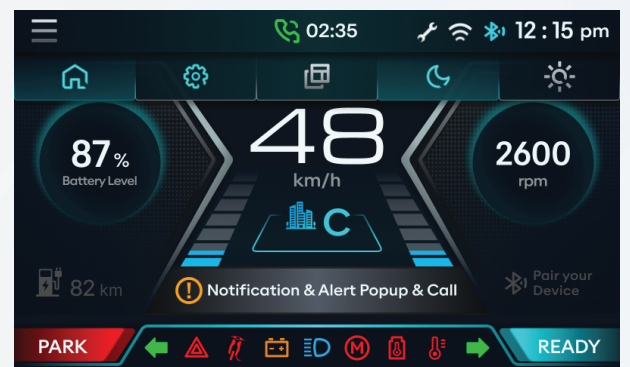

Fig. 42

## Menu Screen Profile

- From menu screen touch / navigate through handle switch to setting to check profile detail and vehicle information.

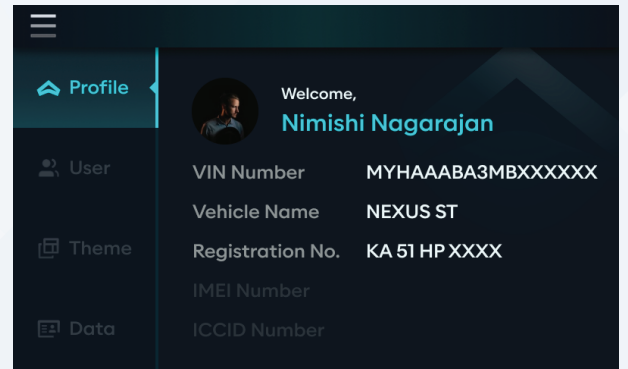

Fig. 43

## Ampere Connect App

Ampere Connect app is available in the Google Play and the Apple store for your NEXUS and it can be installed in your smart phones to access features of your NEXUS.

## Mobile Application Features



Fig. 44

## How to Login

- Open the Ampere Connect app the opening screen will appear.

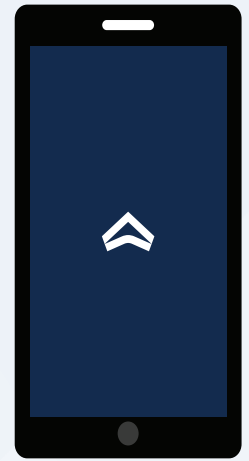

Fig. 45

- User need to allow permissions to access the device location by selecting desired option.

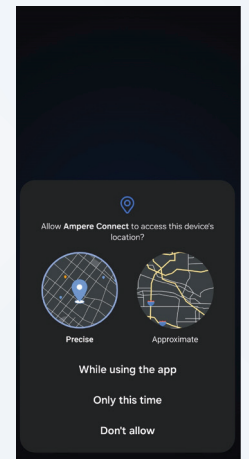

Fig. 46

- User need to allow the following required permissions to access the ampere connect.
  - » Phone call logs
  - » Contacts
  - » Connect to and determine the relative position of nearby devices
  - » Make and Manage phone calls

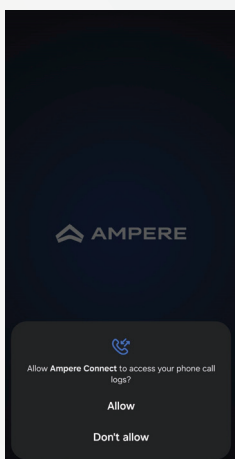

Fig. 47

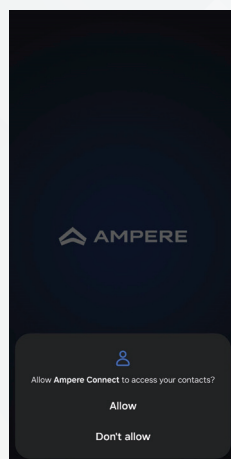

Fig. 48

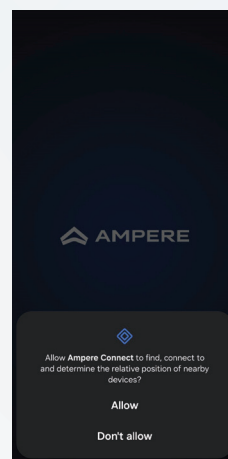

Fig. 49

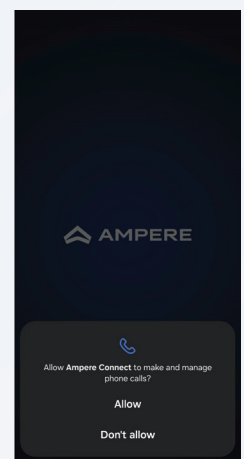

Fig. 50



## Login Page New User

- Select country code and user should enter their registered mobile number.
- After updating click on the "Get to Started".

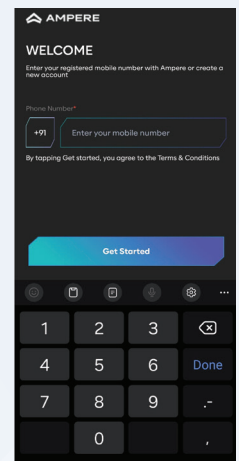

Fig. 51

- User will receive the OTP of 6 digits from Ampere which is used to login into the app.
- If user did not receive any OTP, then click on Resend OTP.
- After entering OTP, it auto-directs to security PIN generation page.

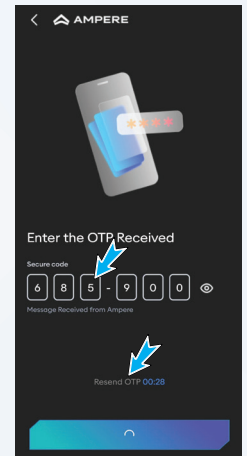

Fig. 52

- Set new 4 Digit MPIN code and confirm MPIN code for safety purpose.
- After updating click on "Continue".

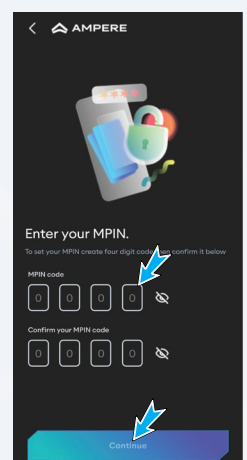

Fig. 53

## Login Page Old User

- For Old user, if they click on application initiation page like "Ampere" will display.
- After a second MPIN page will display.
- The user should enter MPIN and click on "Continue" button.

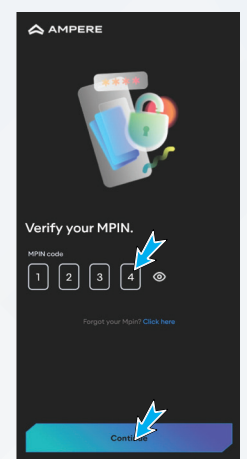

Fig. 54

- If user forgot their password, then they must click on “Click here” text link.

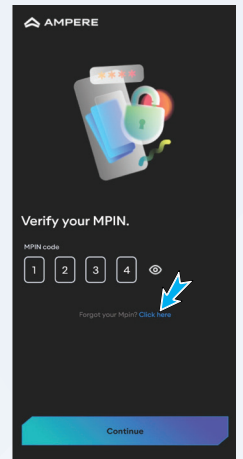

Fig. 55

- It redirects to Login page there they must enter registered phone number and they will get OTP.

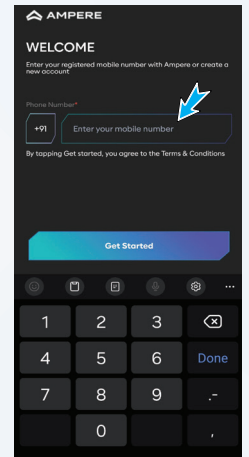

Fig. 56

- After entering OTP, it directs to MPIN page to set new MPIN.
- After updating click on “Continue”.

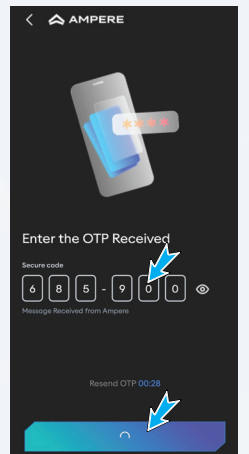

Fig. 57

## Registration

- JOIN AMPERE opening screen will appear on display.
- Update all the mandatory required fields like Full name, Phone number, Emergency contact, VIN number, Date of birth and etc.
- After updating click on “Join”.

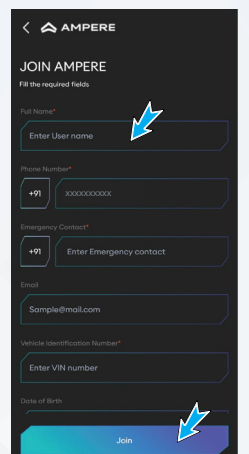

Fig. 58

## Variants

- After joining What's your model screen will appear on display.
- Users need to select his vehicle variant from the following variants for example primus, Nex.io- BLE, Nex.io Plus-IOT.

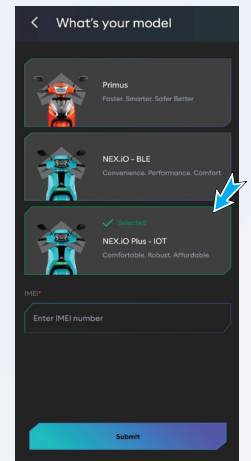

Fig. 59

- After selecting enter IMEI number and click on submit button.

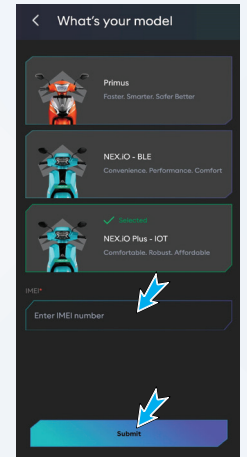

Fig. 60

- After submitting the Home Page will appear on display.
- The following options will appear on the screen.

- |                        |                        |
|------------------------|------------------------|
| 1. Battery Charging    | 2. Range               |
| 3. Day Summary         | 4. Navigation          |
| 5. Home                | 6. Music               |
| 7. SOS Emergency Alert | 8. Bluetooth and Wi-Fi |
| 9. Trip and Distance   | 10. Menu Bar           |

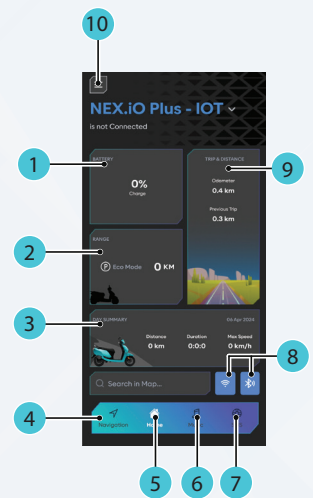

Fig. 61

### 1. Battery Charging

- Select battery.
- Here user will get to know how much battery is charged (%) in battery text field.

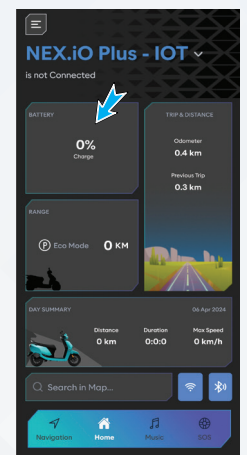

Fig. 62

## 2. Range

- Select Range.
- After submission it will display different modes like Eco, City, Power with different ranges.

## 3. Day Summary

- Select Day Summary.
- After submission it shows details about distance travelled, duration and max speed.

## 4. Navigation

- Select Search in map text field it directs to navigation page.
- Click on Search your location to enter the address and tap on the start button.
- Users can save their address in their favourite address and start the trip.
- After clicking on start button, it will start navigation.

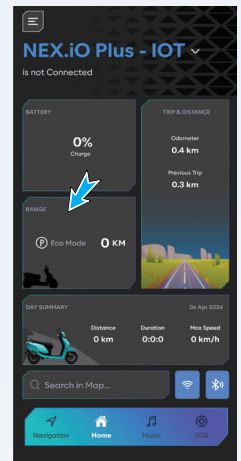

Fig. 63

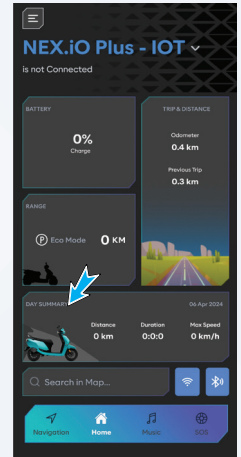

Fig. 64

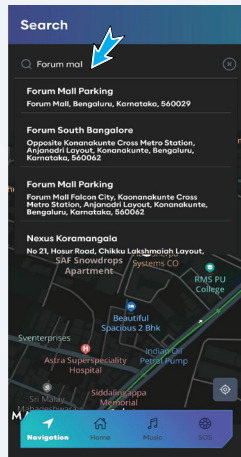

Fig. 65

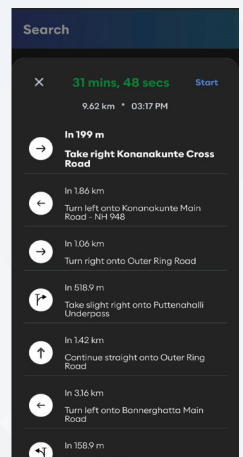

Fig. 66

- Once destination is arrived then navigation will end.

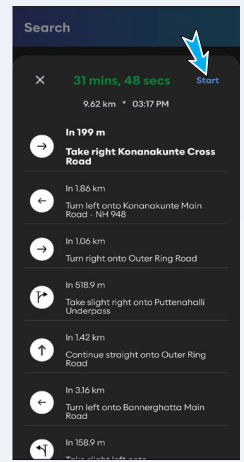

Fig. 67

## 5. Home

- Home is used to bring you back to the Home Screen from wherever you are in app.

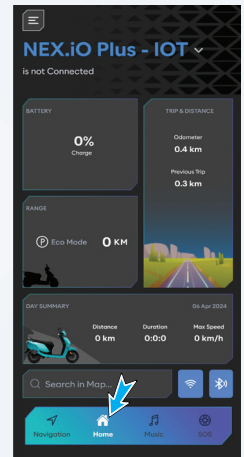

Fig. 68

## 6. Music

- If user click on Music button, they have to give permission for accessing internal storage of mobile so that the songs will display over the page.

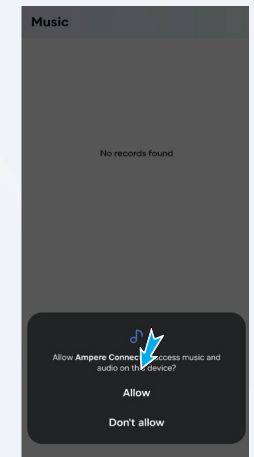

Fig. 69

- User can select songs and start listening.
- Users can see song names, and they can click on the previous, pause, play, and next buttons.

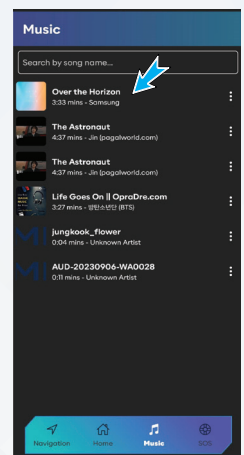

Fig. 70

- Once user selects a particular song, that song will display over cluster with song name and album name.
- If user does any changes on cluster in music screen, then it will reflect in mobile application music page.

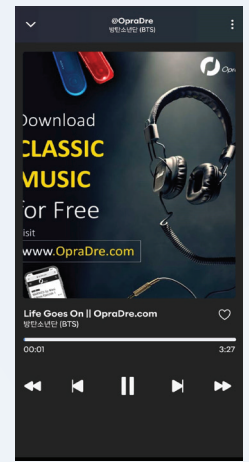

Fig. 71

## 7. SOS Emergency Alert

- Select SOS Emergency Alert.
- After submission a count will start from 10 to 0 for the duration of 10 seconds.
- If the user clicks the SOS button by mistake there will be a provision to stop the timer.

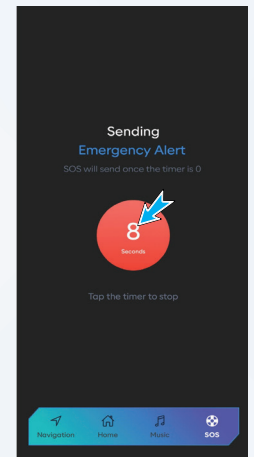

Fig. 72

- Once the timer reaches 0, it will redirect from the SOS Alert page to Message box with the current location to the registered contact.
- Once the user clicks on the send button, a text message will be sent to the registered contact with a note saying that the user (i.e., user's mobile number) is trying to reach you and the current location.

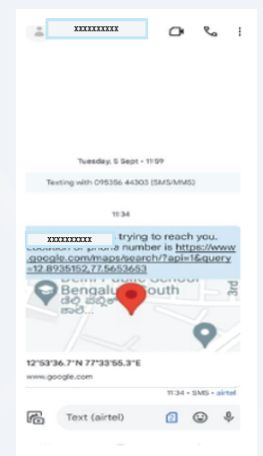

Fig. 73

## 8. Bluetooth

- When user tap on Bluetooth icon in cluster, the name of a particular vehicle will display and then user should select the same name in the application

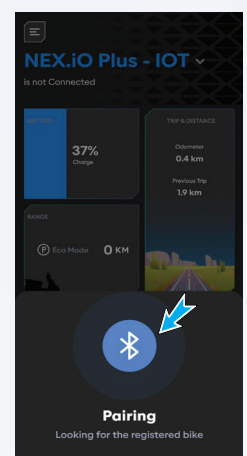

Fig. 74

- When user clicks on Bluetooth button it will display on the screen as “pairing”.
- Select the UID number from list.
- After pairing with Bluetooth, color of Bluetooth should change to blue, and time will reflect over the cluster.

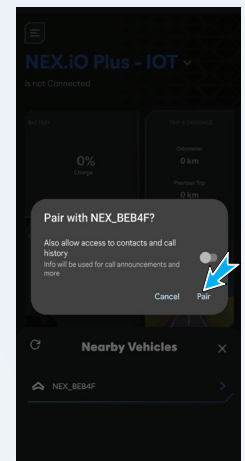

Fig. 75

## 9. Trip & Distance

- Select Trip & Distance.
- After selection it shows ODO value and previous trip value in kms that vehicle travelled.

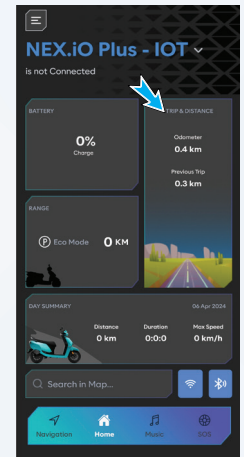

Fig. 76

## 10. Menu Bar

- Select Menu Bar. After selecting the following options will appear on the screen.
  - a. Home
  - b. Profile
  - c. My Scooter
  - d. Trip History
  - e. Settings

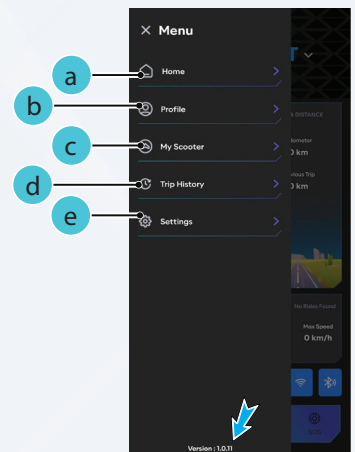

Fig. 77

### a. Home

- Select Home
- Home is used to bring you back to the Home Screen.

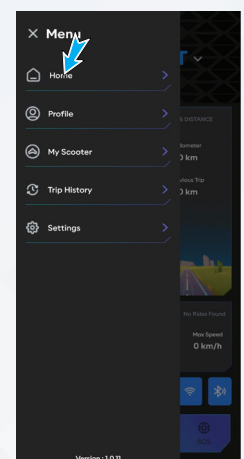

Fig. 78

## b. Select Profile.

- Users can change the image by clicking on the change image link.
- In Profile page user can update their profile by entering respective fields and click on update button.

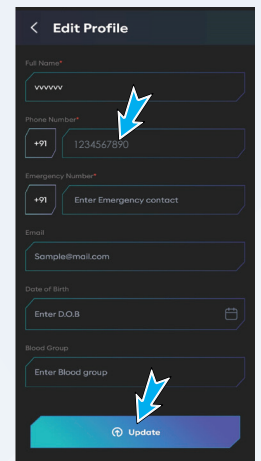

Fig. 79

- User can add their favourite address by clicking on add button and type on search text field and tap on add button.

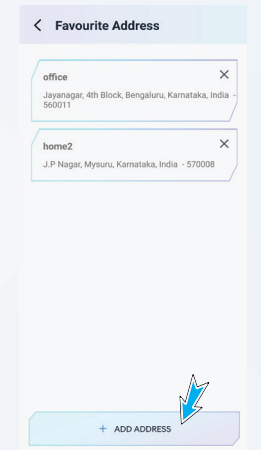

Fig. 80

## c. My Scooter

- Select My Scooter.
- After selection the following options will display on screen
  - » Document
  - » Owner's Manual

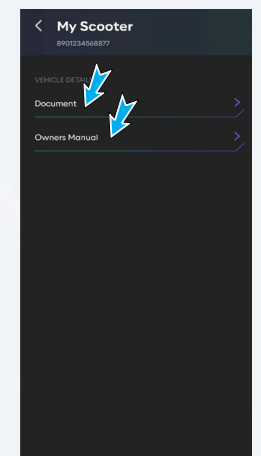

Fig. 81

- Select Document.
- In Document users can attach documents like driving license, registration certificate and insurance with different options like by taking picture with camera or from select from picture.

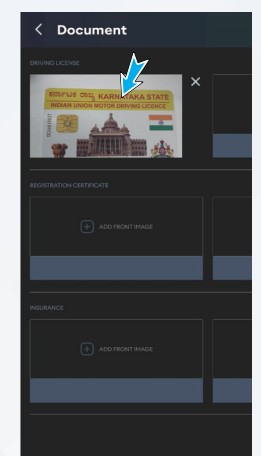

Fig. 82



- Select Owner's manual.
- Users can download the owner's manual.

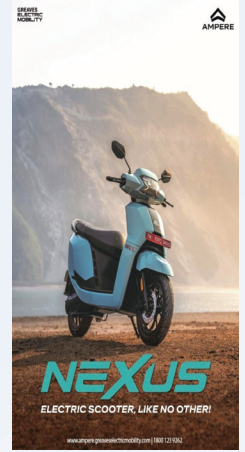

Fig. 83

#### d. Trip History

- Select trip history.
- In Trip history the last ride details are displayed.
- It includes details such as Date, Distance, Duration and Max speed.

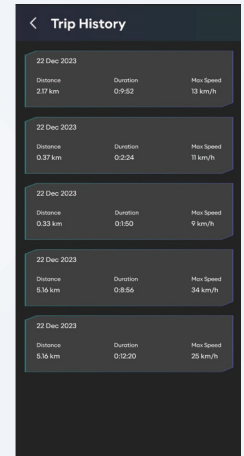

Fig. 84

#### e. Settings

- Select Settings.
- After selection the following options will display on screen
  - » Change MPIN
  - » Theme
  - » Logout

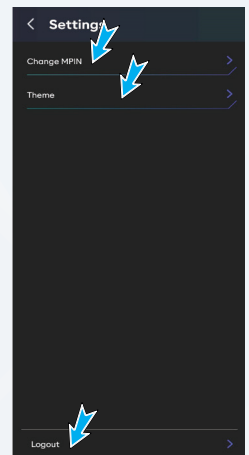

Fig. 85

- Select Change MPIN.
- Users can change their MPIN where they must enter the old MPIN and next they must enter a new MPIN, and they need to enter a confirmed MPIN.

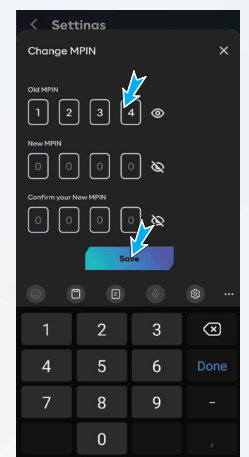

Fig. 86

- Select Theme
- User can do the change from light theme to dark theme.

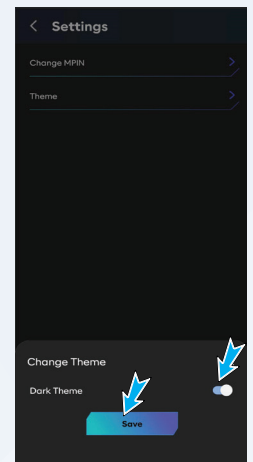

Fig. 87

- Select Logout.
- When a user click on the logout button then the page will redirect to the login page.

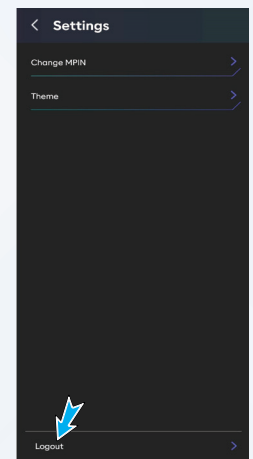

Fig. 88

**Disclaimer:**

***Some software features of the vehicle may not be available to the customer / user at present since the features vary depending on the model or software version of the vehicle/ vehicle's components. Certain features may be accessible only with specific vehicle configurations or updated software versions. Please contact your authorized dealer for detailed information on this.***

## 8. TAKING CARE OF YOUR NEXUS

### Pre - drive Checks

#### A. Check the wheels

- Check if the pressure in the tyres is normal, gauge the pressure of the wheel from the amount of contact it makes with the ground. If the pressure is not normal, use a pressure gauge to measure the pressure when the tyres have cooled down.
- Check for wear and tear or any other damage to the tyre. Check if there are any nails, stones, glasses, or other material stuck to the tyre tube or if there is any damage to it.
- Check the tyre tread wear. If the markings are two-thirds worn out, it is time to change the tyre immediately.

Tyre Pressure (psi)	Front	Rear
Solo	24	27
Dual	25	29

#### B. Check the lights and turn indicators.

- Power ON the vehicle and check if all the lights in the front and rear are in working condition. Check if the headlight glows bright enough.
- Check the front and rear brake lights functioning.
- Check the indicators lights functioning.

#### C. Check the rear-view mirror.

- Make sure that you can clearly see the rear and side area of the vehicle in the rear-view mirror in the driving positions.
- Check whether the rear-view mirror is free from dirt or damage.

#### D. Check the reflector.

#### E. Make sure that the reflector is not dirty or damaged.

#### F. Check the handles.

- Move the handles up, down, front, back, left, and right to make sure that they are not loose.
- Check if the handles are too light to ensure free movement.

### Regular Checks

To help minimize the chances of an accident and possible injury.

#### A. Adjust the brakes

#### B. Check the nuts and bolts

#### C. Check tire pressure

#### D. Transmission oil filling and level check

#### A. Brakes Maintenance

- CBS and rear brake cables may get stretched. Tighten the nuts at the threaded end of the cable to adjust them.
- Inspect the condition of brake pads and brake shoes and then replace the cable if required.
- If the braking effectiveness decrease, check the brake pads.
- If the brake pads are worn out, replace them.
- Brake pad Thickness Service Limit - 1.25 mm.

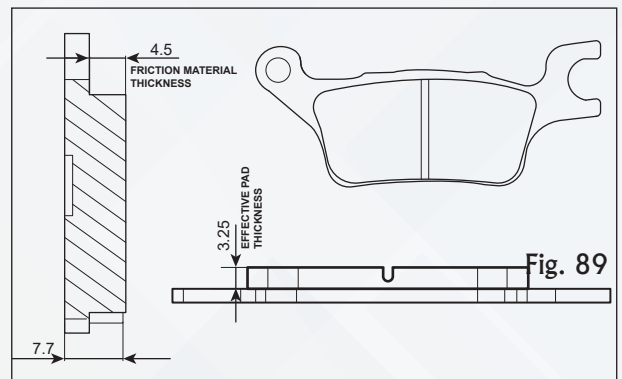

**⚠ Caution**

Replace the brake shoes as a set, if the wear limit indicator shows beyond the wear limit.



Fig. 90

**B. Check the nuts and bolts.**

Check and tighten all the fastener as per the maintenance schedule. If the fastener jam or damage, replace the new one.

**C. Tyre pressure:**

Check the tyre pressure at least once in a week if not more frequently. Insufficient air pressure in the tyres not only hasten tyre wear, but also seriously affects the stability of the vehicle. Under inflated tyres make smooth cornering difficult and over inflated tyres decreases the tyre contact with the ground which can lead to skidding and loss of control. Lower tyre pressure results in less range of the vehicle. Be sure that the tyre pressure is always within the specified limit.

**Tyre Tread Condition**

Operating the vehicle with excessively worn tyres will decrease riding stability and can lead to loss of control. It is recommended to replace the tyre when the tyre wears off to the tyre wear indicator level.



Fig. 91

**Tyre Rotation Direction**

While reassembling the tyres, after removing from the wheel rim, ensure that the arrow mark on the tyre facing the direction of wheel rotation and match the dot mark given on tyre with valve hole present on rim.



Fig. 92

**i Note:**

The tyre inflation pressure in cold condition and the tyre tread condition are extremely important for the performance and safety of the rider. Check the tyres frequently for inflation pressure as well as the wear pattern on it.

**! Caution**

Use of a tyre other than the standard may cause instability.

### Tyre Puncture

Your scooter is fitted with a tubeless tyre on both front and rear wheel. In case of any puncture / tyre damage, it is advised to visit the nearest dealer or the tyre repair shops who knows the repairing method of tubeless tyre. It is not necessary to remove the tyre from wheel rim always to attend a puncture, even though if there is need of tyre removal, it is strongly recommended to use a tyre removal / fitment machine. If at all, tyre levers needs to be used, the levers should be free from sharp edges.

**i Note:**

Care should be taken not to damage the tyres and rims.

**! Caution**

The side walls of the tubeless tyres, which contact with the wheel rim, serve the purpose of sealing the air inside the wheel assembly. Therefore, it is essential to exercise caution to avoid damaging the side walls of the tires during the removal or reassembly process.

If the vehicle is in a stationary condition for an extended period,

- It is recommended to place the vehicle on a stand to elevate the tires slightly. This helps prevent flat spots from forming on the tire contact area.
- Check the inflation pressure when the tires are in a cold condition. Ensure that the maximum travel distance does not exceed 1 km.

## D. Transmission oil filling and level check

### Transmission Oil Draining

1. Place the vehicle on center stand on a flat surface.
2. Wipe - off the surroundings of oil filling cap and remove the cap (1) along with O - ring (2).
3. Place suitable oil tray or container at the bottom of drain plug to collect the oil.
4. Remove the transmission oil magnetic drain plug (3) along with copper washer (4).
5. Let the transmission oil drain out completely into the oil tray.

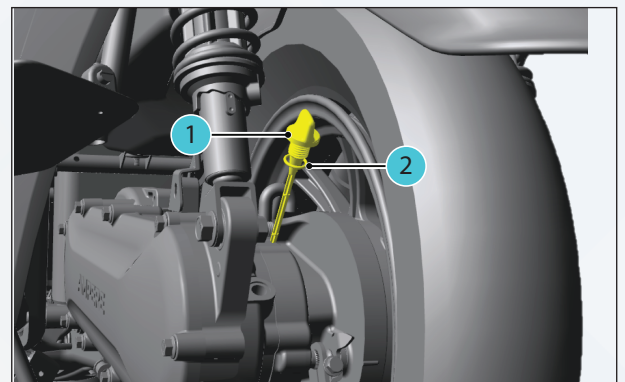

Fig. 93

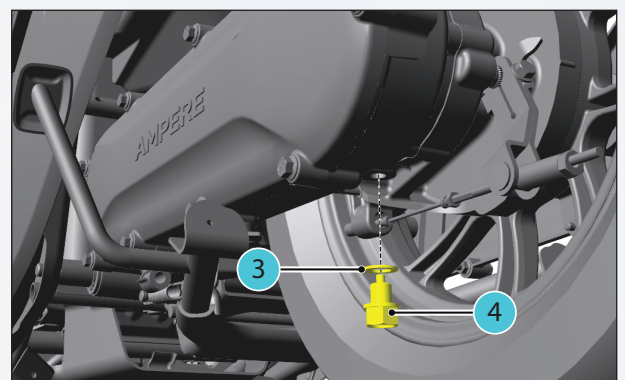

Fig. 94

## Transmission Oil Refilling

1. Wipe out the oil traces on the drain plug and swing arm structure with a clean cloth.
2. Install the transmission oil magnetic drain plug (1) along with new copper washer (2).
3. Installation note: Tightening Torque - 22 - 25 Nm. Do not reuse the drain plug if it is damaged.

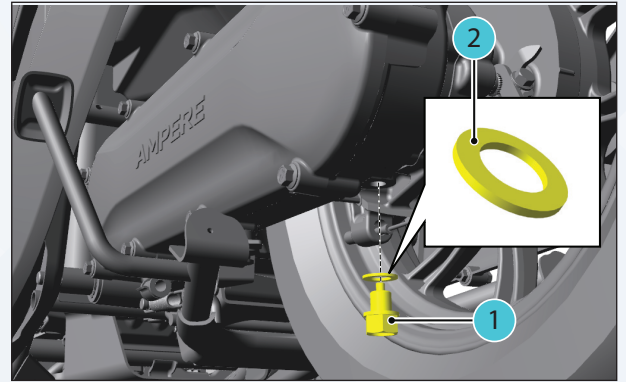

Fig. 95

4. Fill the new oil into the oil filling hole according to the specified quantity of  $125 \pm 5$  ml.
5. Check the oil level in oil filling cap.
6. Install the oil filling cap (3) along with O - ring (4).
7. Installation note: Do not reuse the O - ring if it is damaged. Replace with new O - ring if required.

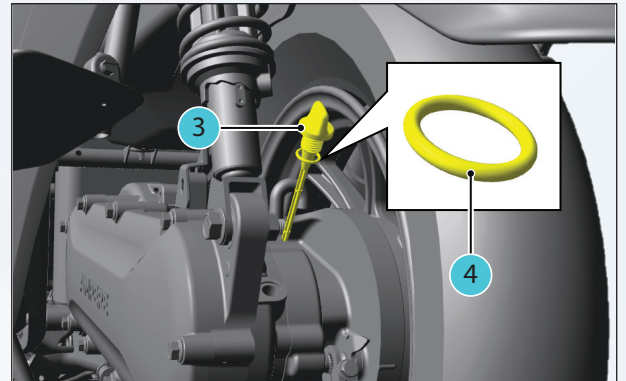

Fig. 96

## Transmission Oil level check

- Place the vehicle on center stand on a flat surface.
- Remove the oil filling cap and wipe the dip stick clean.
- Re - insert the oil filling cap in its hole by threading it in completely.
- Once again remove the oil filling cap and check the oil level.
- The oil level should be between the minimum and maximum level marks on the Dipstick as shown.
- If the oil level is below the minimum level, top - up with the recommended oil up - to the maximum level.
- Note: Check the condition of the O - ring and replace it if required. Ensure the availability of the O - ring in the Dipstick during reassembly.

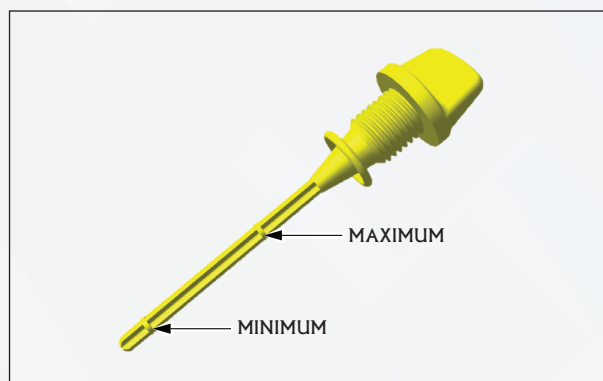

Fig. 97

## 9. VEHICLE MAINTENANCE SCHEDULE

Regular inspections and maintenance, along with good ride handling skills are a must for a great experience.

### PERIODIC MAINTENANCE CHART

Replace - R

Tighten - Tl

Inspect - I

Set - S

Clean - C

Adjust - A

Lubricate - L

Top up - T

Torque - To

Drain - D

Service	Free Service	Paid Service			
		1000	5000	10000	15000
Kilometers	1000	5000	10000	15000	20000
Period from the date of sale	1 Month	6 Months	12 Months	24 Months	36 Months
Swing - arm bolt tightness	I & A	I & A	I & A	I & A	I & A
Side stand pivot		C, L & A		C, L & A	
Main stand Pivot		C, L & A		C, L & A	
Gear / Transmission noise and operation		I & C		I & C	
Belt tensioning & belt dust cleaning	I & A	I & A	I & A	I & A	I & A
Gear box oil / Transmission oil	R	R	R	R	R
Steering operation	I & A, L if required	I & A, L if required	I & A, L if required	I & A, L if required	I & A, L if required
Front axle nut tightness	I & S	I & S	I & S	I & S	I & S
Tyre pressure front & rear at cold condition	I & S	I & S	I & S	I & S	I & S
Brake cam & pivot pin - rear	I & L	I & L	I & L	I & L	I & L
Brake shoe wear - rear	I, C / R	I, C / R	I, C / R	I, C / R	I, C / R
Rear brake cable free play	I & A	I & A	I & A	I & A	I & A
Brake pad wear - front	I, C / R	I, C / R	I, C / R	I, C / R	I, C / R
Brake fluid	-	I & T	I & T	I & T	I & T
Brake hose	I	I	I	I	I
Fork oil	-	-	-	-	-
Tyre wear & condition	I / R	I / R	I / R	I / R	I / R
Rear shock absorber	I / R	I / R	I / R	I / R	I / R
Disc	I / R	I / R	I / R	I / R	I / R
Front fork	I / R	I / R	I / R	I / R	I / R
Hardware - rear shock mounting, disc mounting, caliper mounting, master cylinder mounting, fork mounting bolt on under bracket, CBS assembly mounting on handlebar	I & S	I & S	I & S	I & S	I & S
Mirrors	I & S	I & S	I & S	I & S	I & S

- Clean brakeshoe & drum after checking.
- Check the rear brake play periodically. However, the brake play needs to be adjusted frequently depending upon the usage.
- Fork oil - replace at 30,000 kms or 2 years. Fork oil quantity per leg assembly :- 80±3 CC
- Replace shock absorber in case of oil leakage or bump stopper crack.
- Replace front brake disc in case of thickness reaches 1.25 mm.
- Replace fork oil seal in case of leakage.
- Replace front fork in case of scoring marks on fork pipe.
- Belt replacement - 30,000 kms and Drive & Driven pullys must be replaced at belt end of life. If belt condition is OK, Please continue.

## Battery Maintenance

- Avoid frequent charging if the riding period is short, the battery need not be charged every time. However, put it to full charge once in every 3 days.
- Only use GEMPL charger provided with this vehicle. Other chargers may have a different charging profile resulting in battery damage.
- Release the throttle and apply both the brakes gradually to reduce the speed of the vehicle.
- Avoid sudden acceleration or braking, as this could affect the vehicle performance on long run.
- Do not leave charger ON for more than 6 hours and switch off soon after charging.
- Ensure the brake levers are released before throttling.
- Do not charge the battery immediately after driving it, give it a rest period of at least 30 minutes after use.
- Do not use the vehicle / battery immediately after charging it completely. Give it a rest of 15 minutes after removing the charger before using the vehicle.
- Strictly do not charge the battery near high temperatures.
- To maintain optimal conditions, avoid parking the vehicle in direct sunlight or areas with high temperatures. Always aim to park the vehicle under shade and charge the battery in a well-ventilated area.
- If the scooter has not been in use for prolonged periods of time (30 days), charge and discharge the battery at least once during a month and keep it at 50 % charge during this time.

### Do's

- Always place the battery in upright position.



Fig. 98

- Always keep battery in clean and dry area.
- Keep away from sunlight, sparks, heat, fire and any flammable objects.
- If a LI - ION battery over heats, hisses or bulges, immediately move the device away from flammable materials.
- Always charge the battery with designated charger only.
- To avoid deep discharge, charge the battery to full capacity for the first time and whenever system is kept in storage / inactive for 45 days or more.
- Remove the charger connection if the battery is not charging.

### Don'ts

- Do not keep any vibrating components near or on the battery.
- Do not reverse the polarities of battery or charger during charge or usage.
- Do not charge with a non recommended charger.
- Do not deep discharge the battery below the specified limits.
- Do not put the battery in combination with primary batteries (such as dry cell batteries) or batteries of different capacity, type or brand.



- Do not pull / rotate the breather valve.

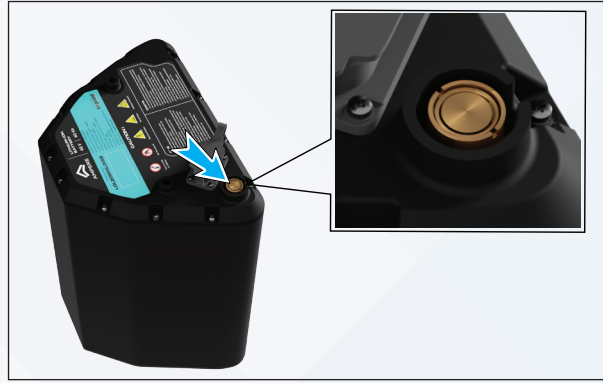

Fig. 99

- Do not open, throw, drop or puncture the battery pack. Do not open the screws present on the battery pack.

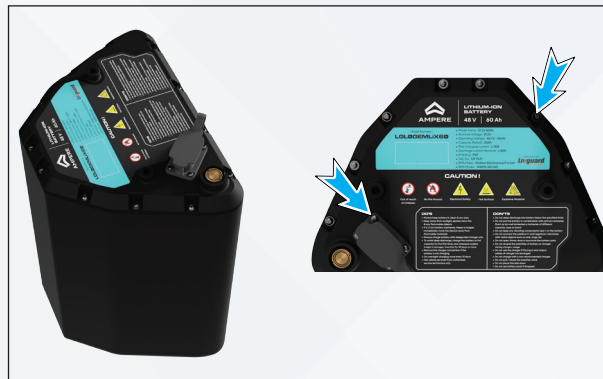

Fig. 100

- Do not use the charger if the input and output cables of charger are damaged.
- Do not connect the positive and negative terminals with metal objects such as wire, rings etc.

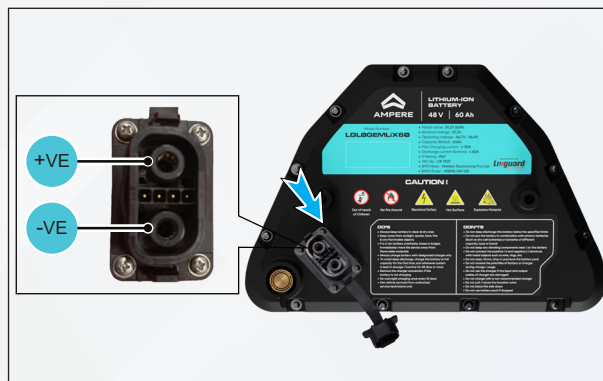

Fig. 101

## Washing Instructions and Do's & Don'ts

- Clean your Electric Scooter Regularly to protect it from the long-term effect of exposure and from exposure that may damage the paint.
- Use only Nonabrasive, PH neutral, safe on paints solutions or shampoos to wash your vehicle.
- Do not use a high-pressure or steam jet cleaner to wash your scooter or its components. Doing so may damage your scooter paints or components.
- We recommend 3M Car wash Shampoo or any equivalent washing agent for shiny and long-lasting colour.
- Before washing, make sure to remove any dirt that might scratch your paints with a low-pressure water spray.
- User one sponge to wash the body and one sponge to clean your wheels and tires.
- After washing your electric scooter with a cleaning solution, it's best to wash again using a low-pressure water spray.
- After wash, brake liner/ pad will take some time for performance restore, until that drive with caution.

## 10. SERVICE & SUPPORT - NEXUS

### NEXUS Warranty Policy

#### Definitions:

This Warranty Policy includes the following words / terms, having the meanings assigned as follows.

- **Battery:** shall mean the Battery which is provided along with the vehicle.
- **Vehicle:** shall mean the Ampere Nexus Electric Scooter.
- **Owner's Manual:** shall mean this document / the manual detailing the technical specifications and guidelines on usage and maintenance of the warranted Part(s) and quick start guide.
- **Warranted Part(s):** shall mean the battery and each component of the vehicle, other than any consumable parts, rubber parts, plastic parts, or tyres or any part which is not covered under this Warranty Policy at Ampere's / Greaves Electric Mobility Private Limited's sole discretion.
- **Warranty Period:** The term of the warranty shall commence from the date of purchase of the new vehicle by the first purchaser. The warranty on each model shall be applicable as per the below table. The warranty period specified below shall depend on whichever occurs earlier.
- **Dealer:** shall mean an authorised dealer who has entered into an agreement with Ampere / Greaves Electric Mobility Private Limited, pursuant to which the dealer may sell as and service the products of Ampere.

S. No.	Part Name	Warranty period	Warranty kms
1	Vehicle Warranty	3 years	30000 kms
2	Auxiliary Battery	18 months	-
3	Battery Liv Guard	3 years	30000 kms
4	Controller	3 years	30000 kms
5	Converter	3 years	30000 kms
6	Motor	3 years	30000 kms
7	Charger	3 years	30000 kms
8	Frame	3 years	30000 kms
9	Cluster	3 years	30000 kms

- Subject to the conditions and exclusions listed herein, Ampere warrants that it will either repair or replace any Ampere - supplied part that is found defective, in material or workmanship, under normal usage conditions through its authorized network. The right to determine whether the part needs repair, service, rectification, or free replacement rests with Ampere only.
- In the event of replacement, Ampere reserves the right to select and use suitable replacement parts at Ampere's sole discretion. All parts removed for replacement under this Warranty Policy will become the property of Ampere and the customer shall have no right therein, whatsoever.

### **Exclusions (1/6) :/**

#### **Ampere shall not have any obligation under this Warranty Policy with respect to the following:**

- Items which are subject to wear and tear, rubber parts, plastic parts, consumable parts are not covered under warranty.
- Proprietary items like Tyres etc, are subject to Warranty terms and conditions of respective manufacturers and would be directly handled by them.
- Painted / plastic parts, cables, bulbs, seals, damaged / tampered parts are not covered under warranty.
- Repairs and adjustments caused by improper maintenance, lack of required maintenance, or repair or service by an unauthorized service center, or the misuse of electric components and battery, other than the way it is specified in the Owner's Manual, would not be covered under the warranty policy.
- Warranty shall cover only the manufacturing defects. Normal wear / tear, any defects arising due to neglect, corrosion, external damages, intrusion of foreign or deleterious matter, lack of servicing or abuse by the continued use of the Vehicle after a fault has become evident, or for consequential loss on the failure of parts or due to mishandling of the Vehicle / parts will not be covered under warranty.
- Damages due to the negligence of Customers or damages caused by accidents and non-preventable events and / or natural calamities including but not limited to flood, earthquake, fire will not be covered under warranty.
- The warranty will cease to exist if the original serial number on the frame or motor of the Vehicle is removed, defaced, distorted, or altered.

### **Exclusions (2/6) :/**

- Cosmetic or surface corrosion of the Vehicle caused by stone chips or scratches in the painted area is not covered under warranty.
- The warranty is not applicable, if the failure of parts is due to improper handling, servicing by unauthorized dealers / technicians, willful abuse or by the destruction by fire. In such cases, the repairs (parts and labour) and all other expenses related to the transporting the Vehicle to and from Ampere or its authorized dealer is to be borne by the customer.
- Cleaning and polishing the Vehicle or the parts will not be covered under warranty.
- Replacement of parts undergoing wear and tear like worn brake pads and lining, shall not be covered under warranty. The same shall be done at the Customer's expense.
- Normal noise, vibration, wear and tear, or deterioration such as discoloration, fading, deformation or blurring and seat cover discoloration of the Vehicle is not covered under warranty.

### **Exclusions (3/6) :/**

#### **Vehicle battery warranty will not apply in the following instances -**

- Battery transferred to any other equipment / system / vehicle.
- Used in non-vehicular application.
- Uneven charging.
- Used in extreme temperature area, which is more than the ambient temperature.
- Leaving the battery under fully discharged condition for a prolonged duration time.
- Damage due to fitment of additional accessories other than the original fitment.
- Battery cover is attempted to be opened / opened by force.
- Breakage of container and / or cover.
- Short circuit due to misuse or wrongful testing.
- Charging the batteries with other brand chargers / non-recommended chargers.
- Using unauthorized charging profiles and fast charging options.

## **Exclusions (4/6) :/**

### **Motor warranty will not apply in the following instances.**

- Motor screws are found open or missing.
- Motor Burnt due to overloading vehicle beyond rated capacity and used to climb the gradient 16 degree max.
- Motor, Phase Cable and sensor cable are found tampered with.
- Any kind of unauthorized welding is done on the motor or related parts.
- Motor Serial no. not matching as per company / dealer record.

## **Exclusions (5/6) :/**

### **Warranty of controller, converter, and charger will not apply in the following instances.**

- Screws on the controller are open and / or missing.
- Track burnt due to overloading.
- MOSFET (Transistor) failure due to continuous overloading.
- Failure due to water or liquid content entering inside the controller.
- Enclosure damaged / connector damaged.

## **Exclusions (6/6) :/**

- Usage of Non Ampere Components: Ampere cannot take responsibility, provide warranty, or accept liability for any damages / failures arising due to faulty non-Ampere components. In these cases, Ampere will not assume any liability costs and the manufacturer of such 'non-ampere parts' shall defend, indemnify and hold Ampere harmless against third parties claim.
- In event of usage of products outside the released applications or environments outside the agreed product specification, no warranty shall apply and Ampere shall not be liable for such products or any damage caused by such products.

## **OTHER TERMS AND CONDITIONS**

- The Customer shall be solely responsible to read and understand the Owner's Manual, Warranty Policy, Purchase Terms and all the product warnings before operating the Vehicle.
- The warranty is non-transferable and is only applicable to the first owner of the Vehicle.
- There will be no charge against the warranty repairs (parts and / or labour) except for consumables. Repair and replacement of parts covered under this Warranty Policy will be carried out by Ampere or its authorized dealers only.
- Further, the above-mentioned warranty shall, in no case, extend to payment of any monetary considerations or replacements or return of the Vehicle to the customer. The Warranty Policy is limited only to the extent covered hereunder.
- Ampere or entities authorized by Ampere will not be held liable for any special, indirect, remote, incidental, or consequential damages of any kind including depreciation, loss in value of the Vehicle, loss of use or income due in full or part directly or indirectly due to a breakdown of the Vehicle and Ampere's maximum aggregate liability at no point will exceed the cost covered under the Warranty Policy.
- Further, the Customer shall be responsible for performing all recommended and necessary routine care and maintenance and engage in proper use of the Vehicle and Warranted Part(s) in accordance with the Owner's Manual.
- Documentation related to the Vehicle shall be retained at all times by the Customer and shall be produced to the service center for verification of the relevant details.
- The Customer must present the Vehicle to an authorized service center for any warranty repair within forty-eight (48) hours after a defect is detected after having duly informed Ampere of such defect.
- Vehicles used for racing or any competition or used otherwise than for ordinary personal transportation shall not be covered under this Warranty Policy.

- Ampere shall only bear the costs of spares and labor for replacement of any Warranted Part(s) under this Warranty Policy. Any additional costs including transportation costs will not be covered under this Warranty Policy and the same shall be at the sole responsibility and risk of the Customer.
- This Warranty Policy has been provided by Ampere and no other entity including the authorized dealers, service centers, its employees or agents have the authority to amend, add to, extend or in any manner modify the warranty provided under this Warranty Policy.
- Ampere shall have the right to make changes to the design or functioning of its Vehicle from time to time and shall not be under any obligation to provide these changes for Vehicles that have been previously sold by it.

### Owner's Responsibility

- Owners are instructed to please take proper care, properly use, and ensure the maintenance of the scooter as per the instructions provided in the Owner's Manual. If the scooter is subjected to severe usage conditions, such as operating in extremely dusty, rough, or heavy city traffic during hot weather or during the monsoons, maintenance of the scooter may have to be done more often.
- Maintenance service records of the scooter will be available with the Company. It may be pertinent for the customer to retain maintenance records also for their records.
- To maintain the validity of this Warranty on the scooter, the scooter must be serviced by the Company Authorized dealership in accordance to the Owner's Manual.

### After-Sales Service and Guarantee

In order to protect your legal rights, please retain a copy of this Manual. Kindly carry out spot checks and adjustments if required for your vehicle during purchase. You hold all rights to request the Dealer or sales personnel to brief the vehicle operation instructions, maintenance requirements and proof of purchase invoice, service guarantees and battery warranty cards, duly signed and sealed from where the vehicle is purchased. It is mandatory to provide the proof of purchase and the warranty card to the dealer to get your vehicle serviced or for battery servicing.

#### **Warning**

For any dispute arising out of words / commitments from behalf of the Dealers, Ampere leaves such responsibility to the Dealers. Ampere will supply spares only till the warranty period as per this book. Warranty, other than that mentioned in this book, communicated orally, written, or given in any other form by any means, is invalid.

# WARRANTY CARD

MODEL NAME \_\_\_\_\_

REGISTRATION NUMBER \_\_\_\_\_

OWNERS NAME \_\_\_\_\_

ADDRESS \_\_\_\_\_

\_\_\_\_\_

MOBILE NUMBER \_\_\_\_\_

CITY \_\_\_\_\_ STATE \_\_\_\_\_

PIN \_\_\_\_\_

SOLD ON (DD/MM/YYYY) \_\_\_\_\_ DATE \_\_\_\_\_

INVOICE NUMBER \_\_\_\_\_

VIN/FRAME NO. \_\_\_\_\_

MOTOR NO. \_\_\_\_\_

DC TO DC CONVERTOR NO. \_\_\_\_\_

BATTERY NO. \_\_\_\_\_

CHARGER NO. \_\_\_\_\_

I hereby confirm the warrenty terms and conditions have been explained to me.  
I agree to use this vehicle as per the terms and conditions.

SIGN & SEAL  
OF DEALER

CUSTOMER  
SIGNATURE

# DELIVERY CERTIFICATE

I certify having taken the delivery of one Ampere **NEXUS** bearing the following particulars :-

Invoice Number \_\_\_\_\_ Date of Sale \_\_\_\_\_

VIN / Frame No. \_\_\_\_\_

Motor No. \_\_\_\_\_

DC - DC Converter No. \_\_\_\_\_ Controller No. \_\_\_\_\_

Battery Number \_\_\_\_\_ Charger No. \_\_\_\_\_

I have been explained by the dealer, about correct and safe driving habits, warranty terms and conditions, service schedules, mandatory electrical installation required at many places for battery charging, precautions while charging battery maintenance tips. The vehicle has been delivered in factory fresh condition to my satisfaction.

Customer Name \_\_\_\_\_ Signature \_\_\_\_\_

Authorised Dealer Name \_\_\_\_\_

Seal \_\_\_\_\_ Signature \_\_\_\_\_



**1<sup>st</sup> FREE SERVICE COUPON**

1 month or 1000 kms, whichever comes earlier, from the date of sale

**DISCLAIMER :**

Cost of consumables and spares are not covered under warranty, which should be borne by customer.

NO :

VIN NO :

MODEL : **NEXUS**

SERVICED ON

**SERVICING DEALER STAMP & SIGN**



**1<sup>st</sup> FREE SERVICE COUPON**

1 month or 1000 kms, whichever comes earlier, from the date of sale

**DISCLAIMER :**

Cost of consumables and spares are not covered under warranty, which should be borne by customer.

NO :

VIN NO :

MODEL : **NEXUS**

**DATE OF SALE**

**DATE OF SERVICE**

**SERVICING DEALER CODE**

**SELLING DEALER CODE**

**KMS COVERED**

I hereby confirm that the job mentioned overleaf has been completed on my AMPERE vehicle to my complete satisfaction.

**CUSTOMER SIGNATURE**

**SERVICING DEALER STAMP & SIGN**



## 1st Free Service Inspection Parameters

- Check and tighten the swing-arm bolt.
- Check belt tension and adjust.
- Check steering operation and lubricate, adjust if required.
- Check transmission oil and replace if required.
- Check front axle nut tightness and set.
- Check front & rear tyre pressure at cold condition and set.
- Check rear brake cam & pivot pin and lubricate.
- Check rear brake shoe wear and clean or replace if required.
- Check rear brake free play and adjust.
- Check front brake pad wear and clean or replace if required.
- Check the brake hose.
- Check tyre wear & tyre condition and replace if required.
- Check rear shock absorber for leakage replace if required.
- Check front fork for leakage replace if required.
- Check disc replace if required.
- Check hardware - rear shock mounting, disc mounting, caliper mounting, master cylinder mounting, fork mounting bolt on under bracket, combi brake system assembly mounting on handlebar and set.
- Check mirrors and set.

### **DISCLAIMER :**

Cost of consumables and spares are not covered under warranty, which should be borne by customer.



**THE NEX BIG THING  
FOR THE ONES WHO TAKE CHARGE**

**NEX.iO**

**NEX.ARMOUR**